



HIGH PRESSURE BLOWER

Model HPB Direct Drive/Belt Driven



Model HPB High Pressure Blowers

Aerovent's High Pressure Blowers feature high static pressure capabilities from 11" to 69" and air volume to 6500 CFM. High Pressure Blowers are durable, compact and versatile fans used in applications such as:

- Agitation and aeration
- Product cooling and drying
- Conveying
- Supplying combustion air to furnaces and ovens
- Exhausting
- Transporting solid materials
- Gas boosting and compressing



Landfill Ventilation

Aerovent commonly utilizes Model HPB High Pressure Blowers in landfill ventilation applications to extract methane gas. Methane emitted from decomposed waste in landfill sites can contaminate the surrounding property, through migration, if not properly contained. Typically, a gas collection system collects the methane generated by the waste and uses it to produce electricity for onsite equipment operation or for resale to local utilities. Recovered methane gas provides a clean source of fuel, improves air quality, and reduces greenhouse gas emissions.

To extract methane gas from the landfill, perforated pipes (average 4" diameter) are sunk vertically down into the landfill and back filled with gravel. The pipes are manifolded together at the surface, and connected to the high pressure blower. Gas flows through the pressure blower and then to either a gas collection system or to a flare stack where it is burned off.

Typical Pressure Blower Construction for Landfill Ventilation

- Abrasive and corrosion resistant coating on all air-stream parts (for example, 3055 plasite baked phenolic).
- Thrust vanes on the back of the wheel — to ensure negative pressure where the shaft penetrates the housing.
- AMCA "B" Spark Resistant Construction — for the hazardous methane atmosphere.
- Stuffing Box Shaft Seal — to obtain the best seal against gas leakage, although it does not make the unit completely gas tight. Available only in Arrangement 1 or Arrangement 8.
- Continuous double-welded scroll.
- Explosion Proof Motor (Class I, Group D, Division 1).

Material Conveying

High Pressure Blowers can also be utilized to convey material for industrial processes. An example would be polystyrene, or "Styrofoam," for the manufacture of plastic grocery bags. Styrofoam is difficult to transport by hand because it is light and bulky. A high pressure blower is utilized to pneumatically convey this material from storage containers to the extrusion process for melting, molding and cooling. The polystyrene material is then melted on an extruder ring and air is blown through the ring to form a plastic tube. In many cases a separate high pressure blower is utilized to blow air through the ring. After the tube is formed, one end is heat sealed to complete the forming of the plastic bag.

Contents

Introduction	2
Design Features	3
Drive Arrangements	3
Accessories	4
How To Select A Pressure Blower	6
Performance Data	7
Material Specifications For Standard Units	20
Dimensional Data	21
Typical Specifications	25

©1999 Aerovent

Bulletin illustrations cover the general appearance of products at the time of publication and we reserve the right to make changes in design and construction at any time without notice.

Design Features

Construction

A continuously-welded heavy-gauge steel housing and motor base provide for rugged, heavy-duty service. Rotatable and reversible housings are offered as a standard for all sizes.

An inlet venturi with a guard is standard for all units. A flanged or pipe inlet is available as an option. The standard discharge is an all-welded heavy-duty flange drilled to match American Standard Class 125 bolt pattern.

Wheel

The Model HPB Blower is furnished with an aluminum alloy wheel, and is provided with a split-taper lock bushing for easy wheel removal from the shaft. Standard for wheel sizes 14" through 26" is riveted construction, while size 27" through 30" wheels are welded. Welded steel wheels are avail-



able in all sizes for heat applications (temperatures 300°F to 600°F).

For increased fan capacity, a wider wheel is offered for sizes 22" through 26". These fans are identified as "W" (wide) and the ratings are listed on pages 19 and 20.

Heat Fans

Arrangement 1 and 8 fans are available with optional construction for operation at temperatures up to 600°F. High temperature modifications include a welded steel wheel, special base construction to accommodate a heat slinger and guard, and aluminum paint finish. Fans requiring "W" (wide) wheels are not available with 600°F construction.



Heat Slinger

Drive Arrangements

Arrangement 1

Arrangement 1 has a shaft and bearing assembly designed for the motor to be mounted in one of the four AMCA standard motor positions, W, X, Y or Z.

Standard Unit Arrangement 4

Wheel is mounted directly to motor shaft, providing maximum performance at minimum cost and maintenance. Available for the full range of wheel sizes from 14" through 30". Maximum temperature is 180°F.



*Arr. 4
Drive Side*

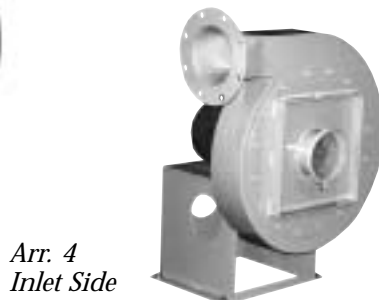

*Arr. 4
Inlet Side*

Arrangement 8

Direct coupled unit with an extended pedestal to accommodate a motor and flexible coupling. Fan assembly can remain intact while removing motor for service. Available for the full range of wheel sizes from 14" through 30". Maximum temperature with aluminum wheel is 300°F.

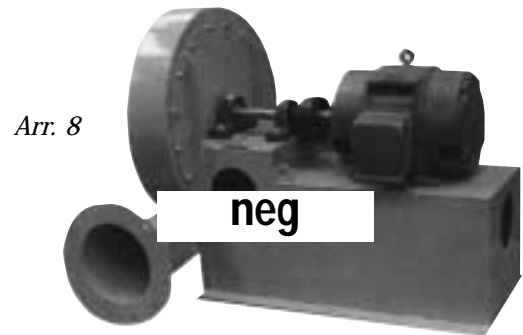

Arr. 8

Arrangement 9

Built to Arrangement 1 specifications, but with an adjustable motor slide base and V-belt drive mounted on the fan pedestal. Motor located on right side as standard. Available throughout the range of sizes, and can be modified for operation at elevated temperatures. Pedestal dimensions limit selection to small motors only. **Consult factory for availability of belt driven Arrangement 9 fans.**

Accessories

Shaft Seal

Four types of friction shaft seals are available:

1. **Elastomeric Rotary Seal** — Rides against a heavy Teflon wear plate. Spare seal provided as standard. Cut off old seal and push spare into place. This seal is suitable for operation up to 300°F.
2. **Ceramic Felt** — Elements are encased between housing drive side and metal retaining plate. Ceramic felt inserts may be easily split for field installation and maintenance. The seal is best suited for 301°F to 600°F operation. These seals minimize leakage around the shaft opening but are not gas-tight.
3. **Lubricated Seals** — For longer seal life. Suitable to 300°F.
4. **Stuffing Boxes** — Constructed of three rows of permanently lubricated packing material encased between the housing drive side and the machined metal packing gland. This shaft seal provides the best seal against gas leakage but is not totally gas-tight. Suitable for temperatures to 500°F. Specify temperature for proper packing material.



Available in Arr. 8 or in Belt Driven Fans Only

Wheel Thrust Vanes

Provide a simple solution to applications which require negative pressure at the point of shaft penetration of the scroll in order to prevent the escape of undesirable fumes or gases.

Outlet Dampers

Control airflow on discharge side of blower. Dampers have manual lever control. Recommended where a pipe is not connected to the discharge side of the blower. Standard damper is suitable for temperatures to 400°F.



Inlet Filters (Weatherhood Shown)

Permanent oil-wetted filters or throwaway cellulose filters are recommended where heavy dust conditions exist. An all-weather hood option is available. Pressure drop through clean filter, less hood, is 0.25" W.G. Specify flanged inlet for mounting. A combination filter/silencer is also available (see page 5).



Flexible Sleeve

Connects fan to standard piping and reduces noise and vibration transmission. Furnished with stainless steel hose clamps.



Tube Adaptor

Bolts to flanged inlet or discharge of fan. Provides connection to American Standard pipe sizes or a flexible sleeve (see above).

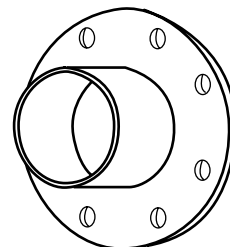

Accessories

Concentric Silencer

The silencer is engineered and designed to effectively reduce objectionable air intake noise.

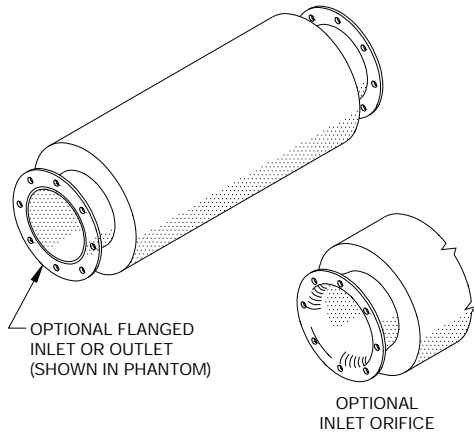

INSERTION LOSS dB EACH SILENCER	SILENCER SIZE	OCTAVE BAND							
		1	2	3	4	5	6	7	8
4	4	4	18	26	33	36	29	23	21
6	6	2	14	23	31	33	28	25	23
8	8	1	11	21	29	30	28	26	25
10	10	2	14	23	30	30	27	25	24
12	12	1	11	24	31	31	27	25	24

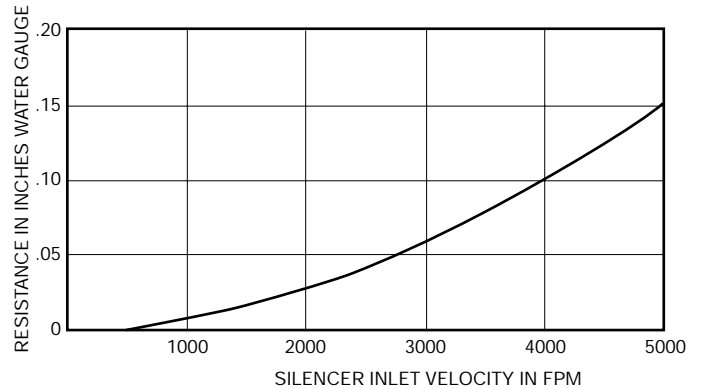

Filter/Silencer

An efficient intake filter with a silencing chamber enables the filter/silencer to meet both requirements.

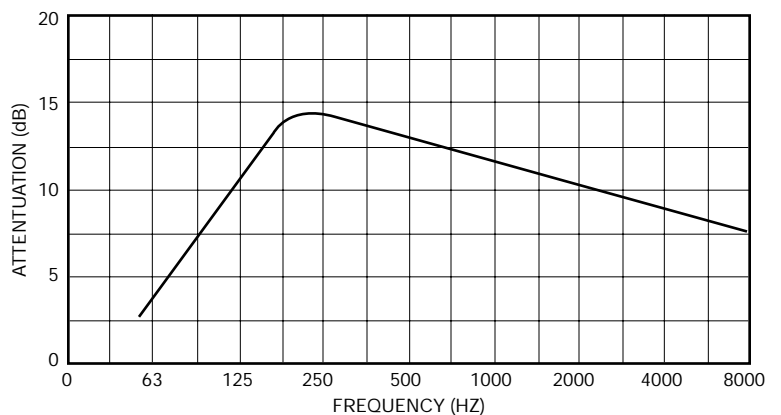
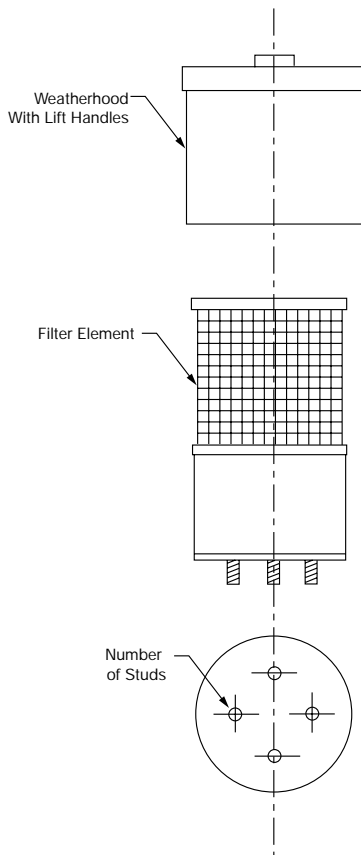

How To Select A Pressure Blower

To select a high pressure blower from the fan performance curves on pages 7 through 20, the system design CFM and SP are needed (at standard density of 0.075 lb./ft³).

For high pressure blowers, it is recommended to select a motor 1 to 2 sizes larger than the performance curves suggest, as described in the following example:

Example 1:

Given a performance of 400 CFM at 25" SP, select a size 19" High Pressure Blower with a 4" diameter outlet. The performance looks as follows (also shown on page 9 of this catalog):

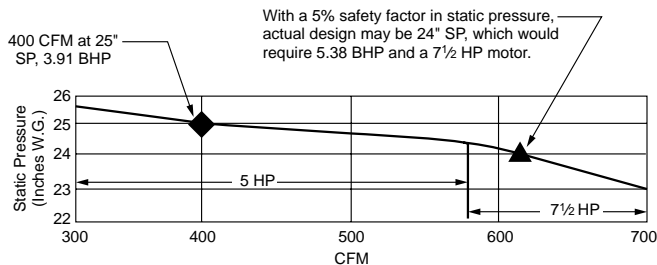

The operating point of 400 CFM and 25" SP is noted above by the diamond shape.

Therefore, the performance point of 400 CFM at 25" SP requires a 5 HP motor.

NOTE: For a 5% or 1" reduction in design static pressure, the performance will require a 7½ HP motor, as shown by the triangle shape. It is common in system design to put a 5 to 10% safety factor on the system static pressure. However, when utilizing this type of fan, it is important to consider its increasing brake horsepower characteristic.

The performance curve for the Size 19", 4" outlet duct High Pressure Blower shown below depicts the increasing brake horsepower characteristic more clearly. For a small reduction in static pressure, the brake horsepower increases.

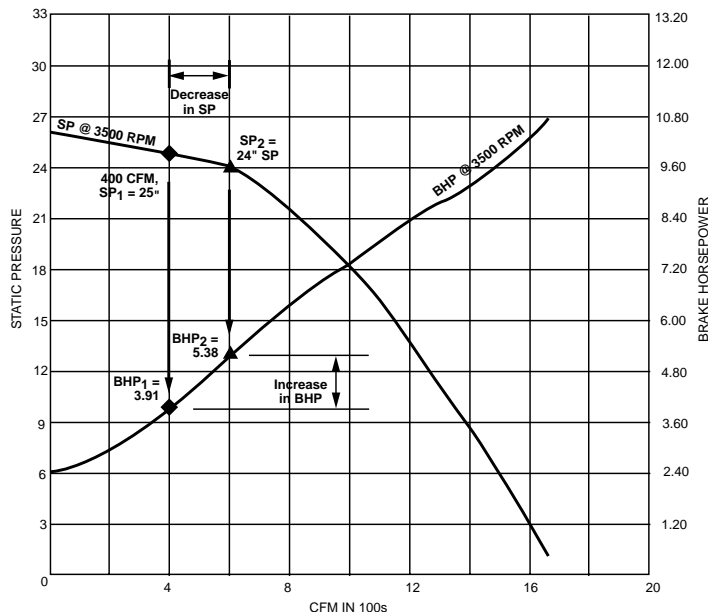

Suction Pressure Corrections For Inlet Suction Conditions

A suction pressure correction is necessary for inlet static pressures (usually 10" or greater). The static pressure is negative on the inlet or suction side of the fan so a partial vacuum is created at the fan inlet. This partial vacuum lowers the density of the air (or gas) or makes the air (or gas) rarefied. Therefore, the air must be converted to standard conditions by using the "Suction Pressure Correction Factor," as shown in the example below.

Example 2:

Given a fan inlet static pressure of 20" at 70°F at sea level, the suction pressure correction ratio is calculated using the following formula:

$$\begin{aligned} \text{Ratio} &= \frac{\text{Ambient Absolute Press.} - \text{Fan Inlet SP}}{\text{Ambient Absolute Press.}} \\ &= \frac{407 - \text{Fan Inlet SP}}{407} \end{aligned}$$

Ambient Absolute Press. = 407"

For this example:

$$\text{Ratio} = \frac{407 - 20}{407} = 0.9509$$

Using this ratio, the static pressure at standard conditions is calculated as follows:

$$\text{SP @ Std. Cond.} = \frac{20}{0.9509} = 21.03" \text{ SP @ Std. Cond.}$$

The static pressure of 21.03" is used for selecting the fan from the performance curves.

Performance Data

The Aerovent Model HPB Blowers shown on pages 7 through 20 of this bulletin have been tested and rated in accordance with industry accepted test codes, and are guaranteed by Aerovent to deliver rated performance.

Performances shown are based on 3500 RPM motor speeds and standard inlet air density of 0.075 lbs./ft³.

Range of performance is within motor horsepower specified.

Catalog Numbering System

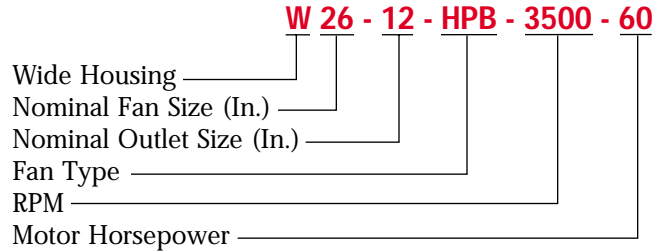

STATIC PRESSURE - INCHES W.G.

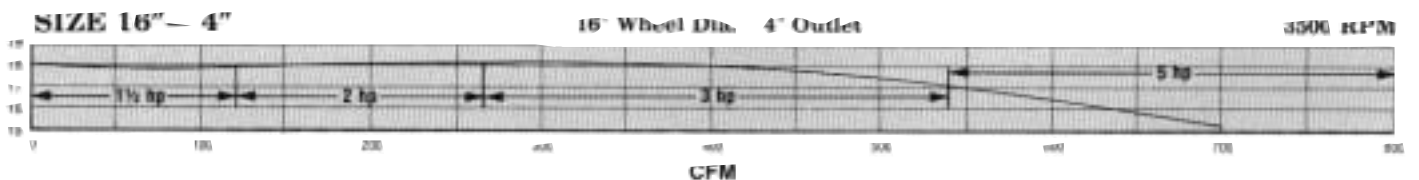
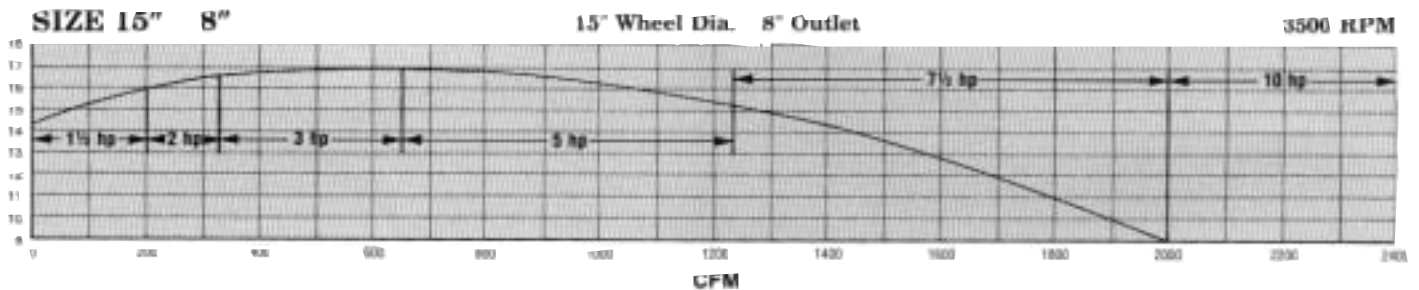
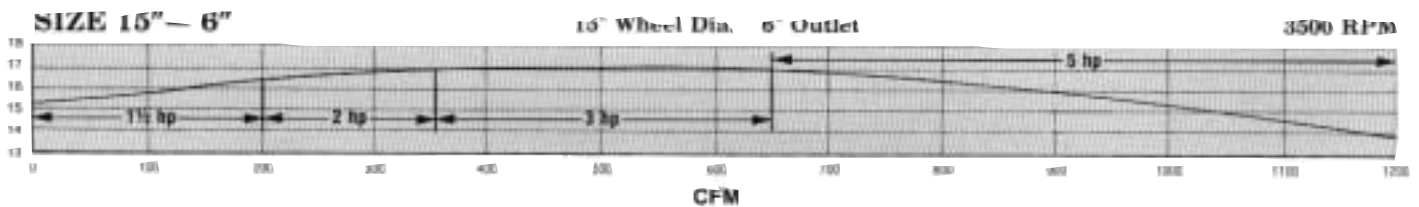
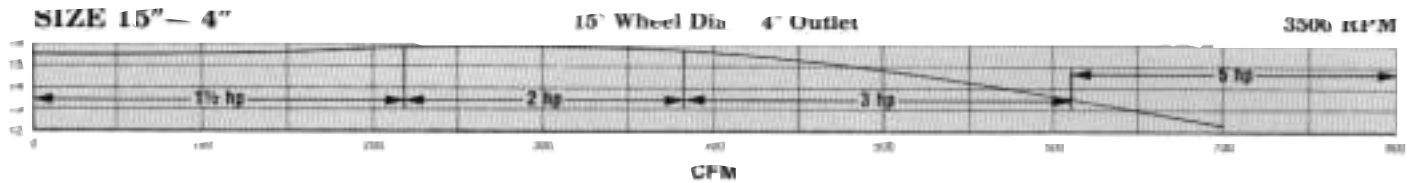
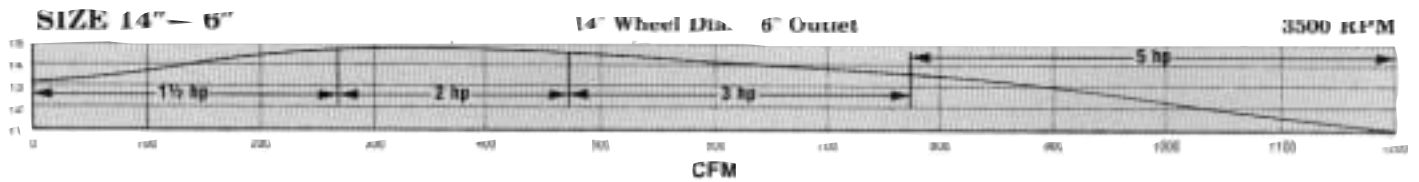
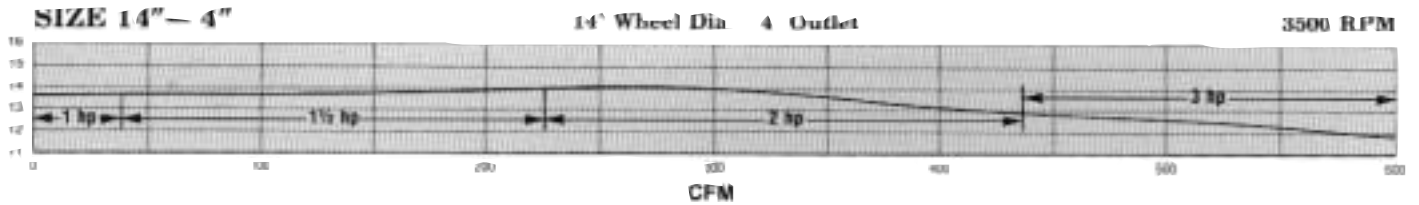

Performance shown is for installation Type D: Ducted inlet, ducted outlet.
 Performance ratings do not include the effects of appurtenances in the airstream

STATIC PRESSURE - INCHES W.G.

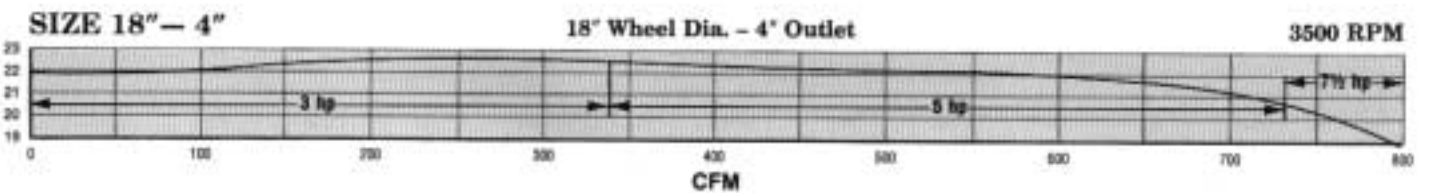
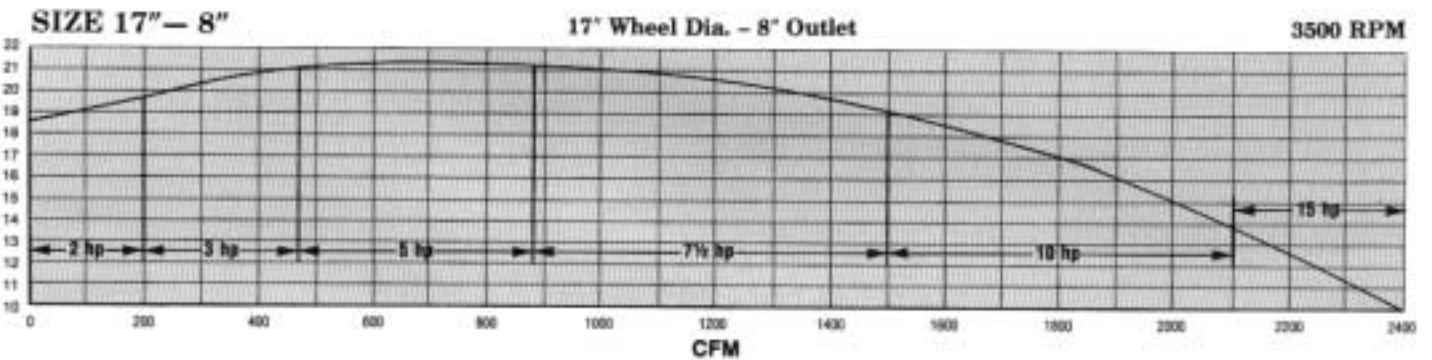
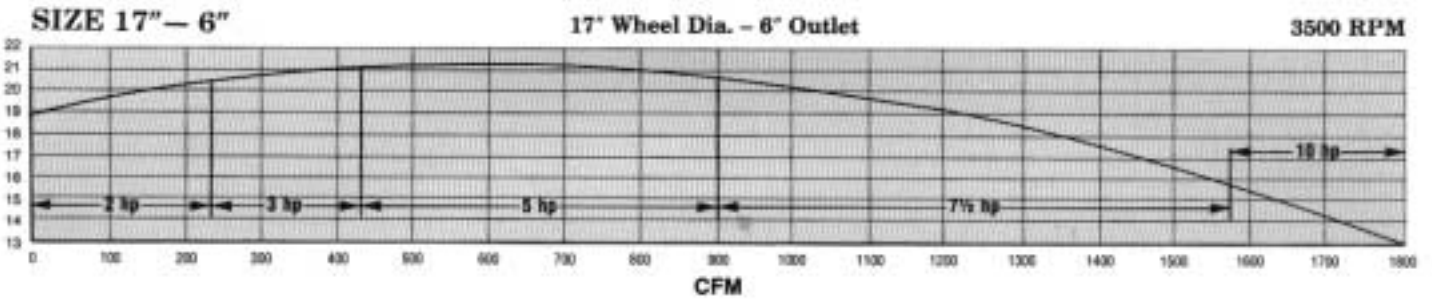
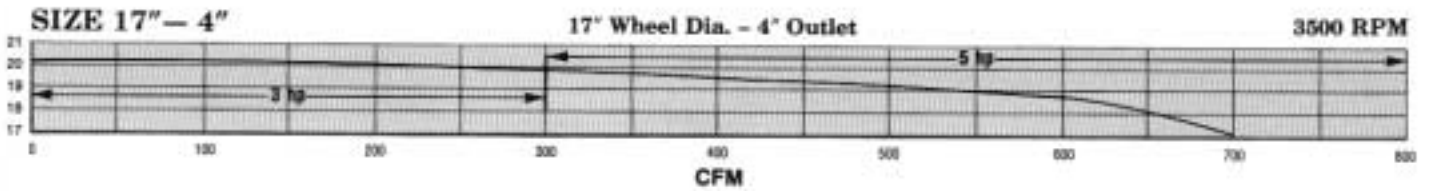
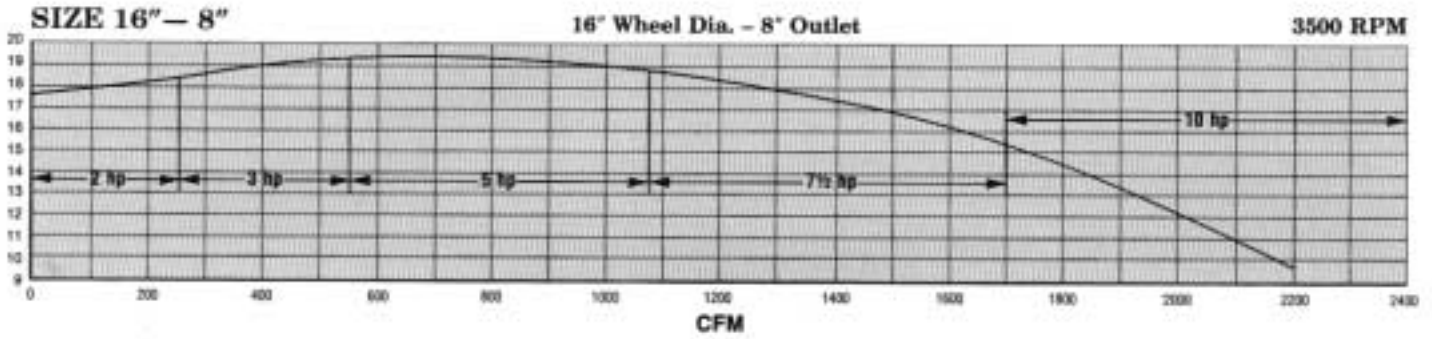
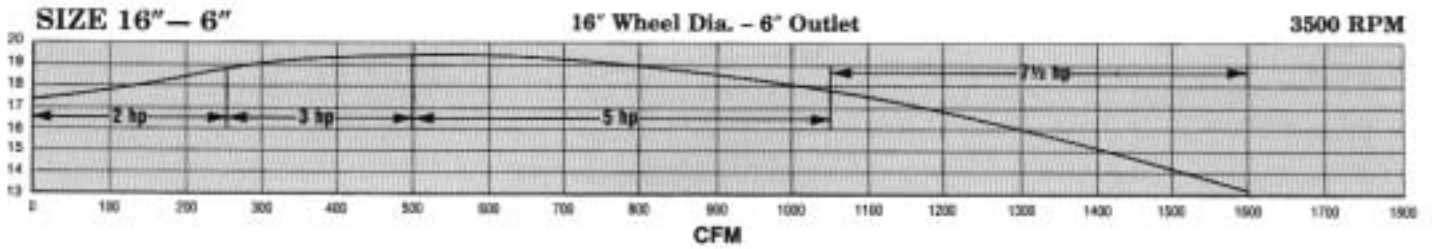

Performance shown is for installation Type D: Ducted inlet, ducted outlet.
 Performance ratings do not include the effects of appurtenances in the airstream

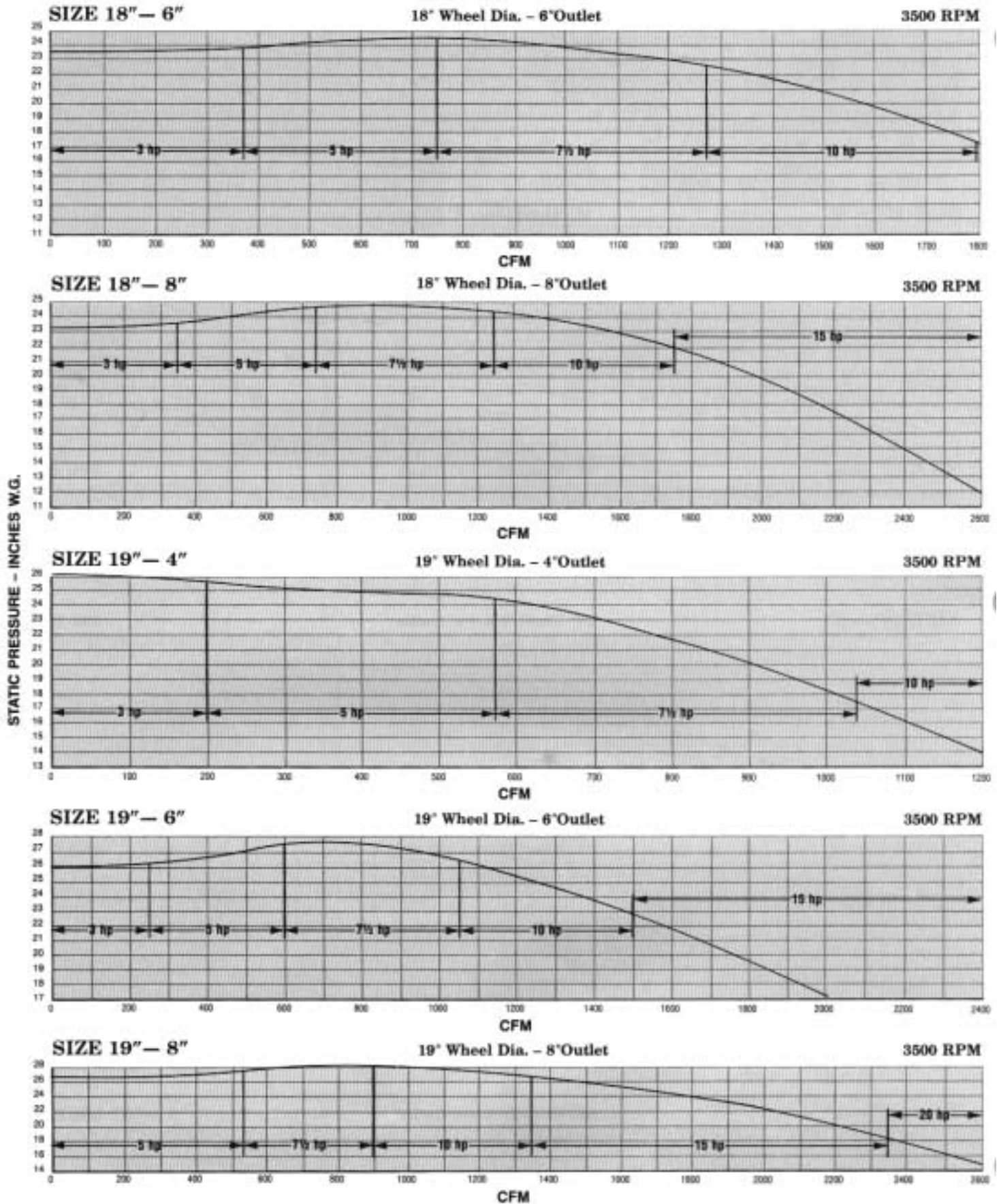

Performance shown is for installation Type D: Ducted inlet, ducted outlet.
 Performance ratings do not include the effects of appurtenances in the airstream

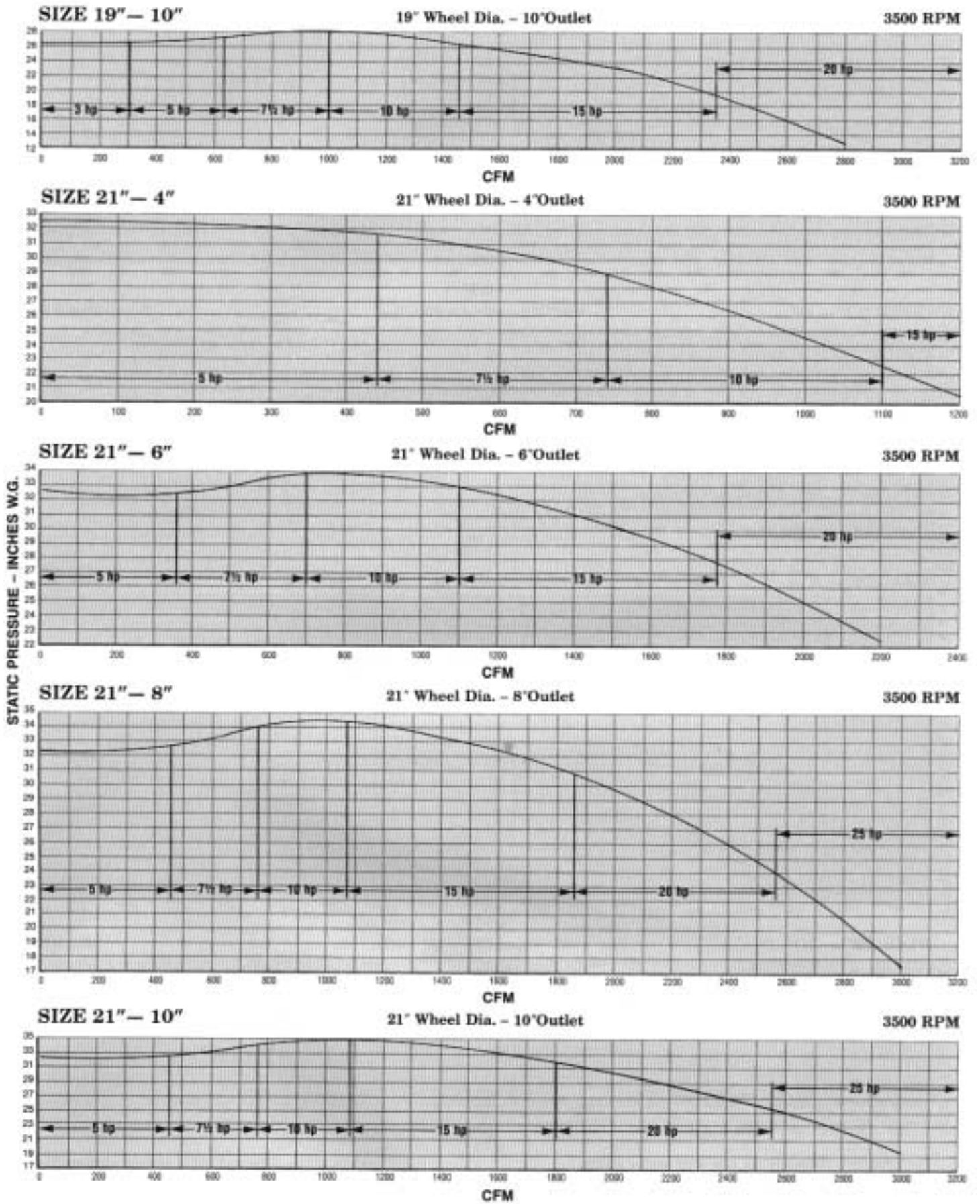

Performance shown is for installation Type D: Ducted inlet, ducted outlet.
 Performance ratings do not include the effects of appurtenances in the airstream

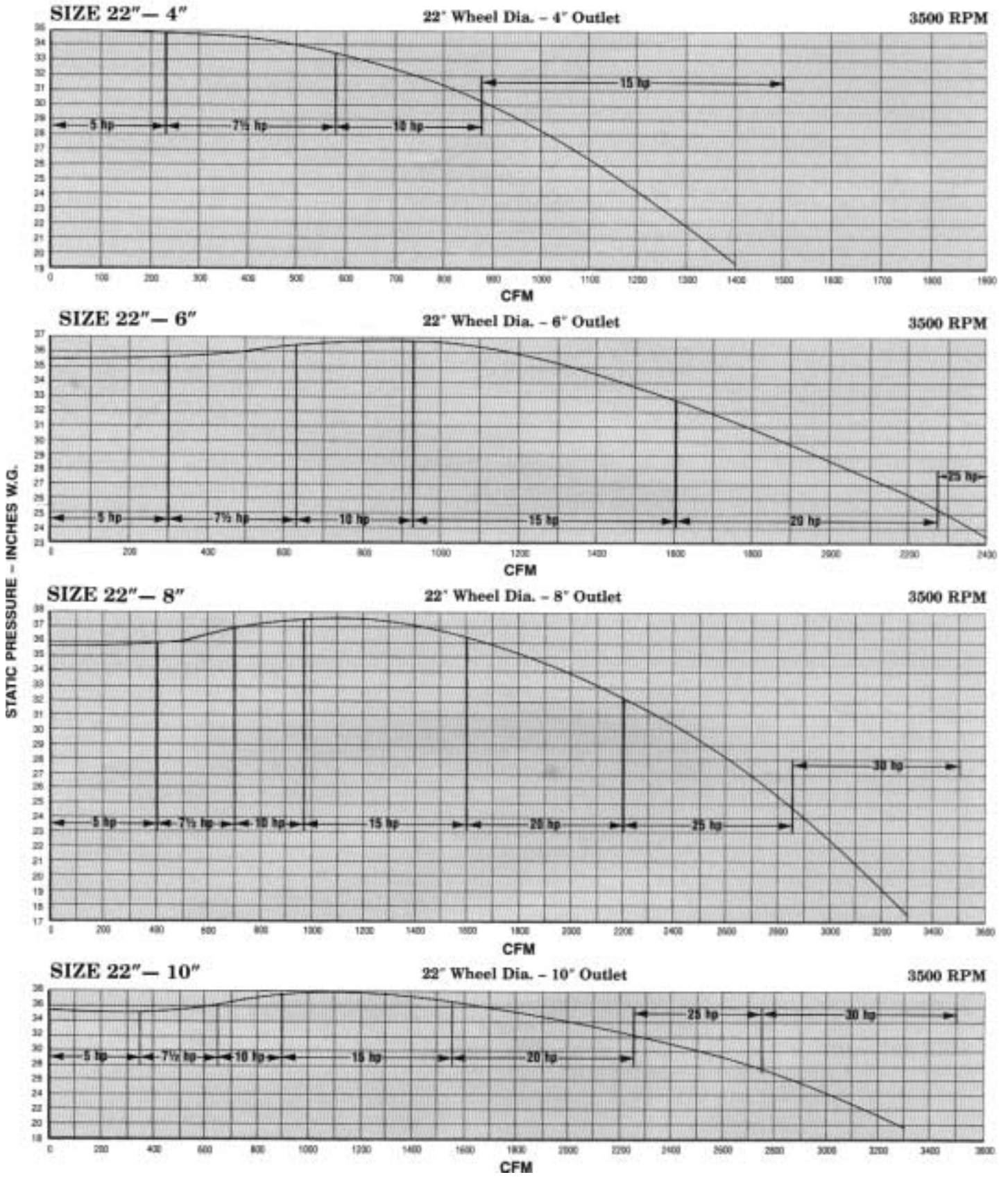

Performance shown is for installation Type D: Ducted inlet, ducted outlet.
 Performance ratings do not include the effects of appurtenances in the airstream

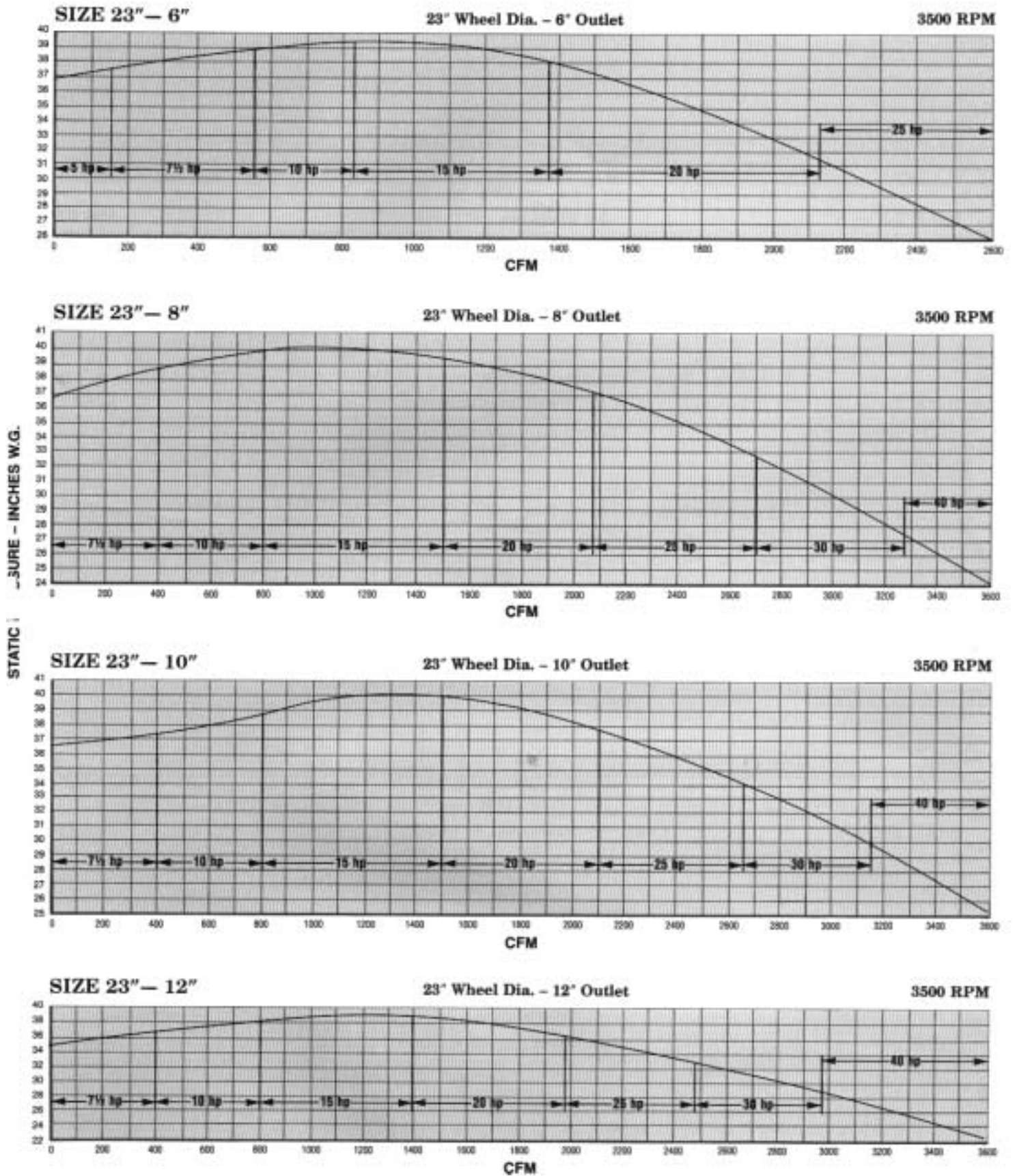

Performance shown is for installation Type D: Ducted inlet, ducted outlet.
 Performance ratings do not include the effects of appurtenances in the airstream

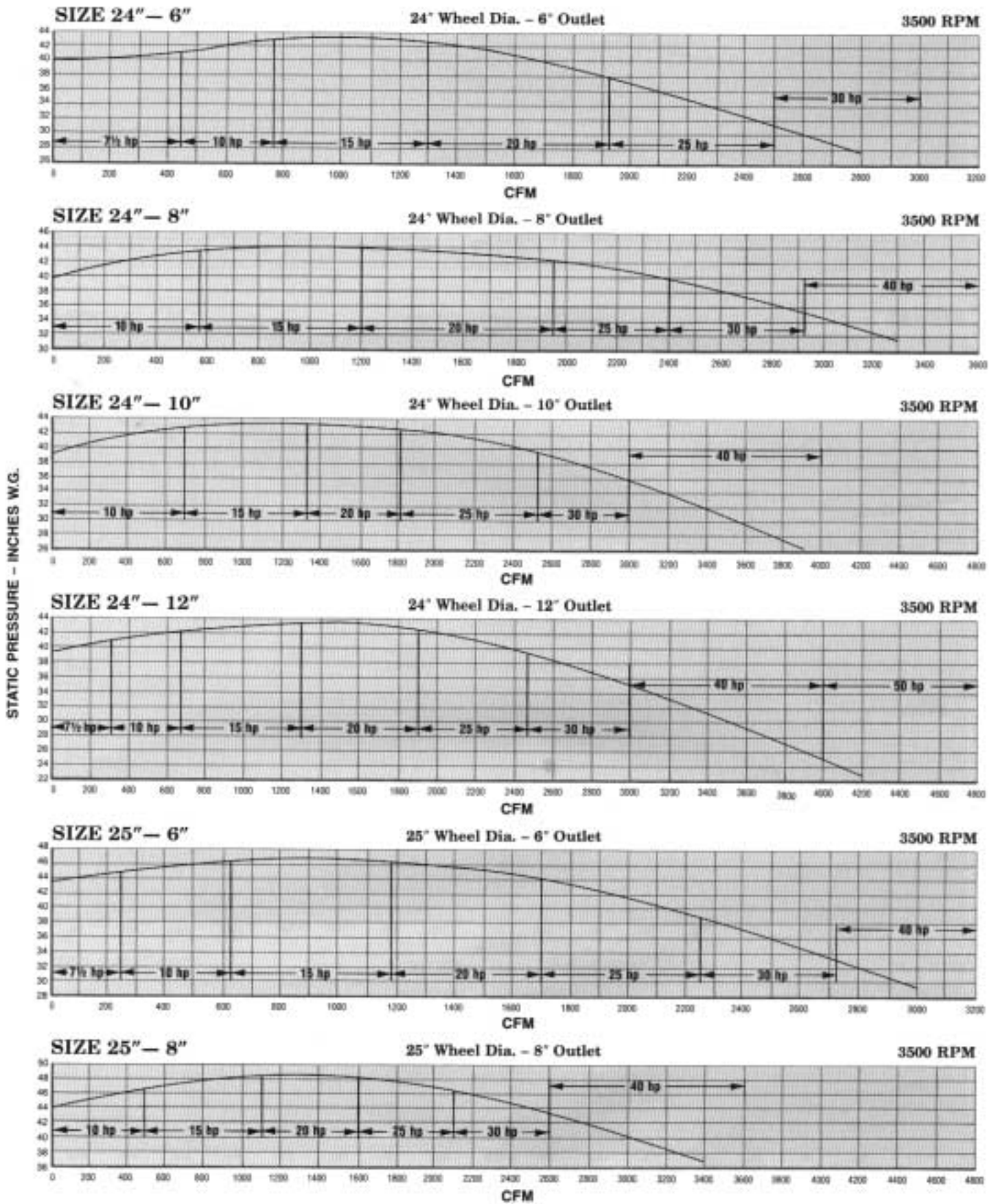

Performance shown is for installation Type D: Ducted inlet, ducted outlet.
 Performance ratings do not include the effects of appurtenances in the airstream

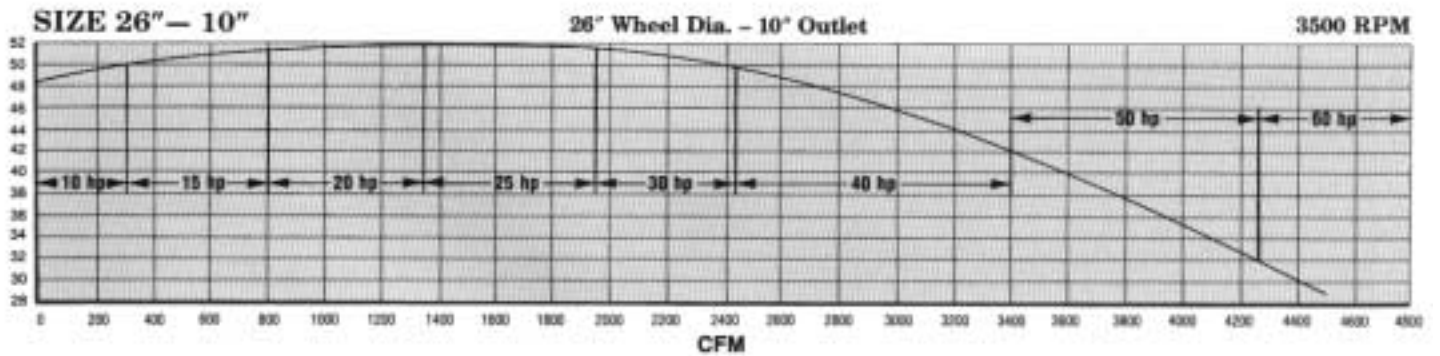
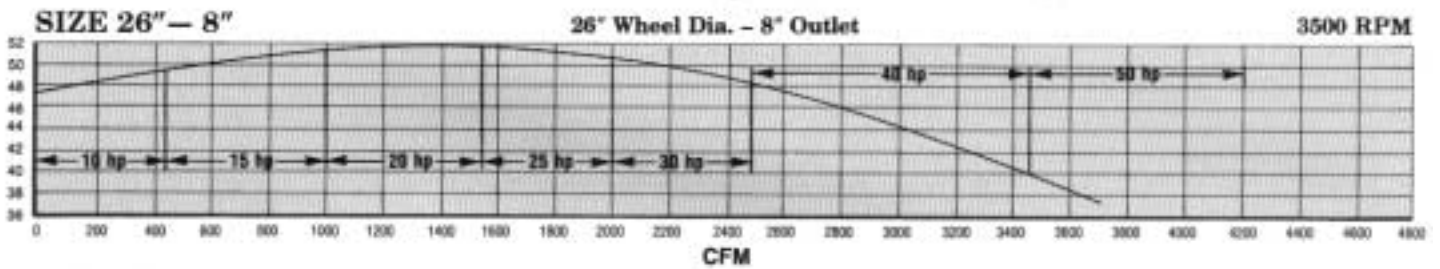
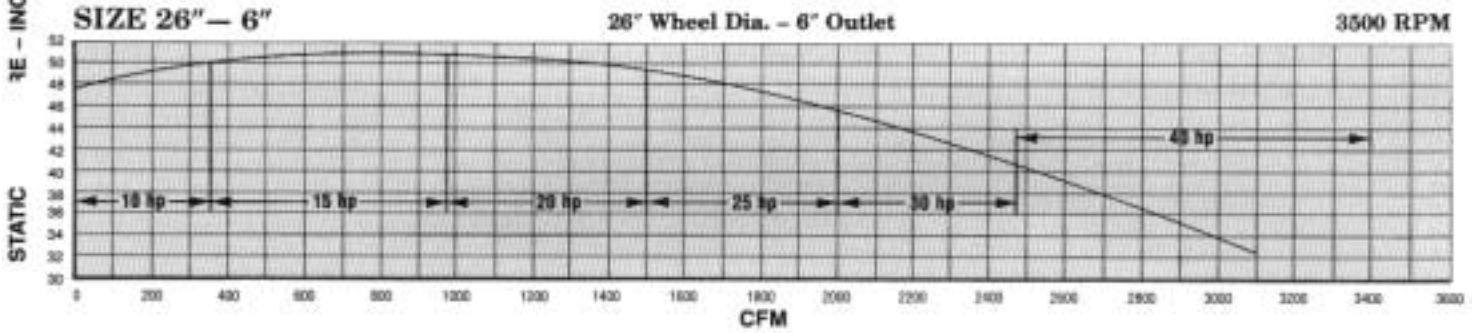
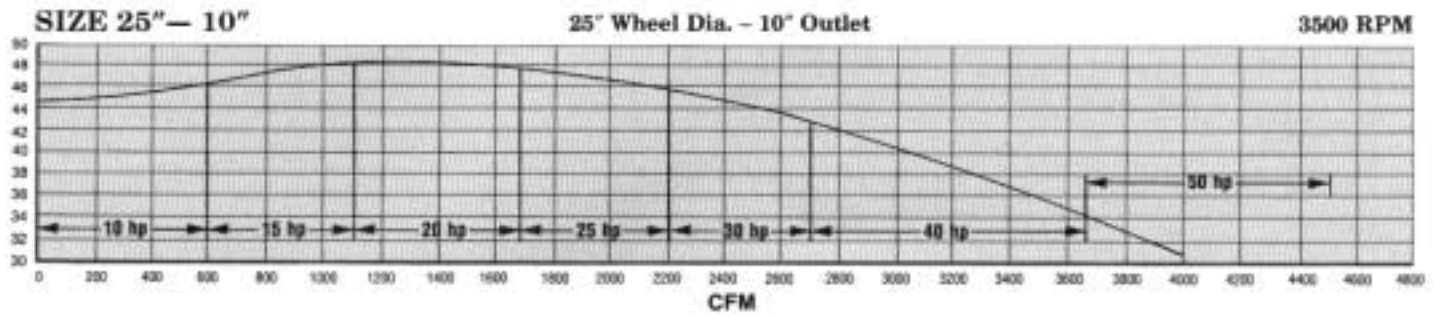

Performance shown is for installation Type D: Ducted inlet, ducted outlet.
 Performance ratings do not include the effects of appurtenances in the airstream

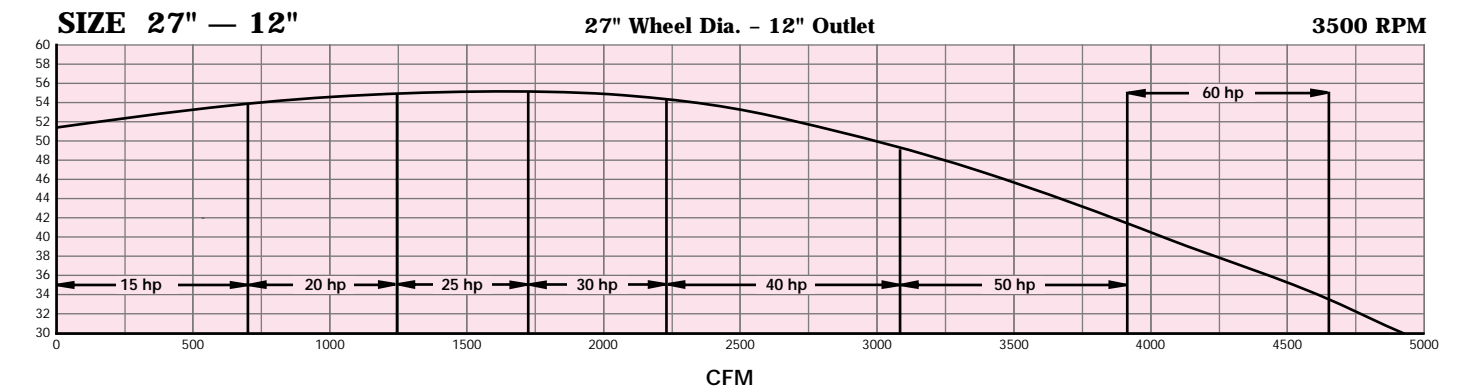
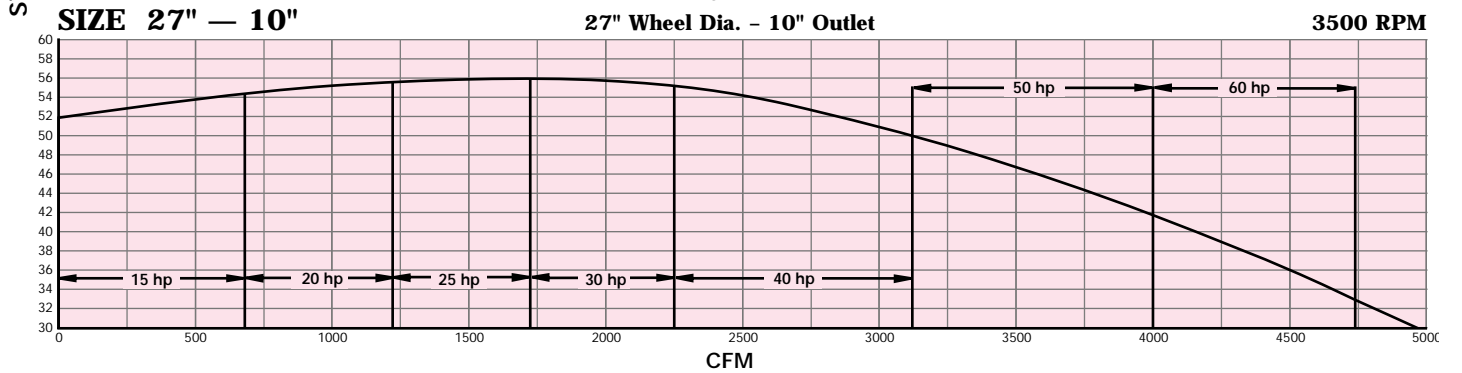
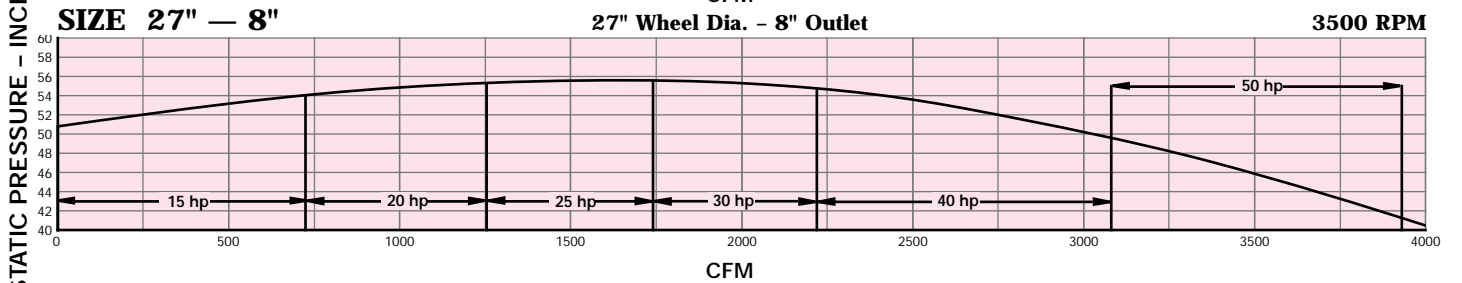
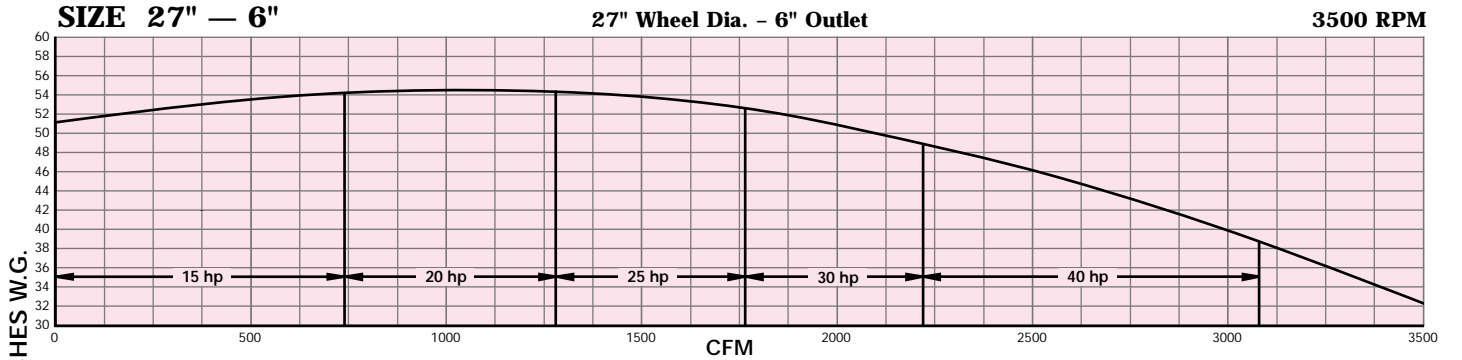
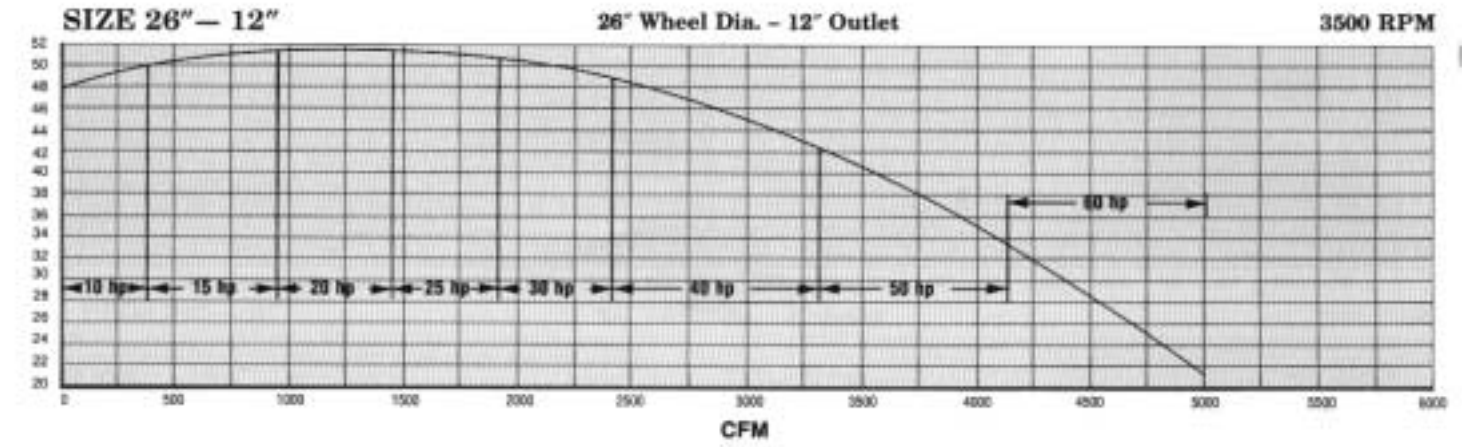

Performance shown is for installation Type D: Ducted inlet, ducted outlet.
 Performance ratings do not include the effects of appurtenances in the airstream.

SIZE 28" — 6"

28" Wheel Dia. - 6" Outlet

3500 RPM

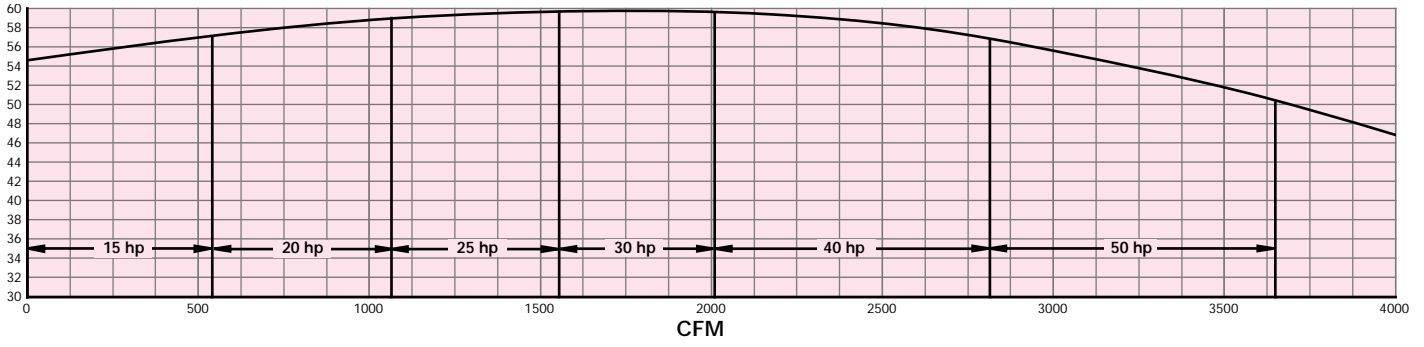

SIZE 28" — 8"

28" Wheel Dia. - 8" Outlet

3500 RPM

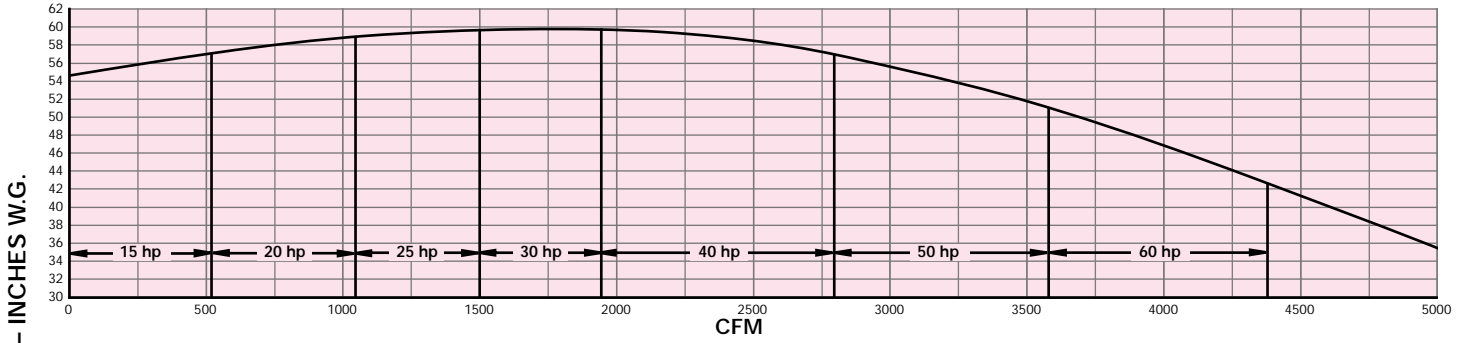

SIZE 28" — 10"

28" Wheel Dia. - 10" Outlet

3500 RPM

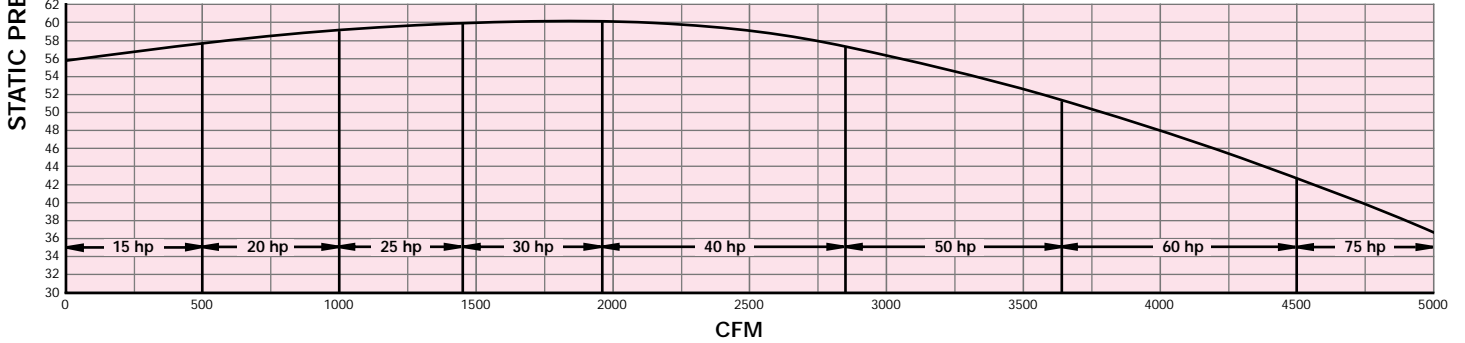

SIZE 28" — 12"

28" Wheel Dia. - 12" Outlet

3500 RPM

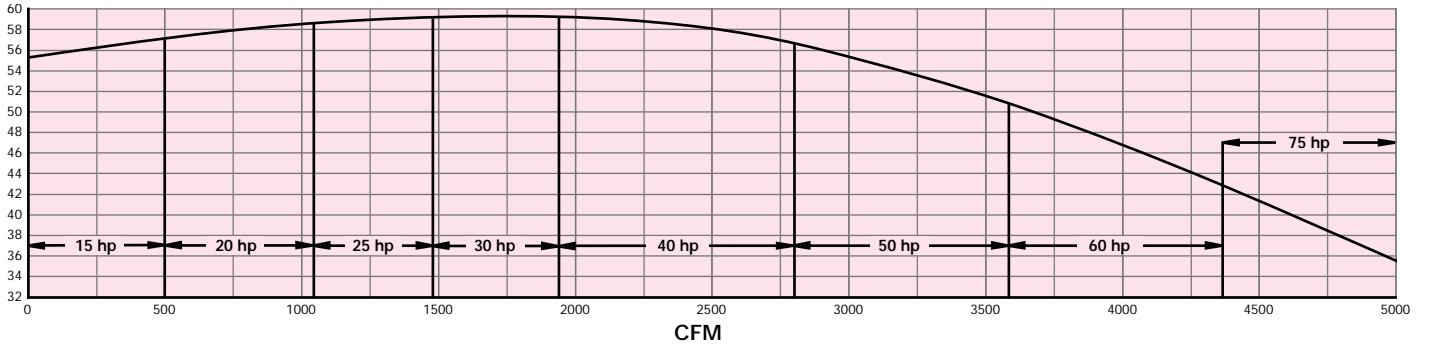

Performance shown is for installation Type D: Ducted inlet, ducted outlet.
Performance ratings do not include the effects of appurtenances in the airstream.

SIZE 29" — 6"

29" Wheel Dia. — 6" Outlet

3500 RPM

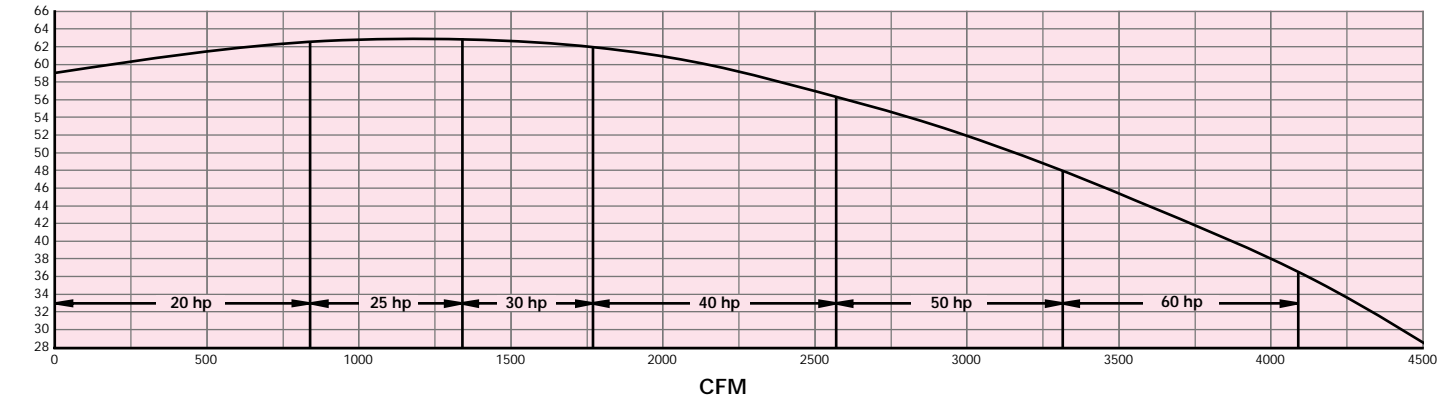

SIZE 29" — 8"

29" Wheel Dia. — 8" Outlet

3500 RPM

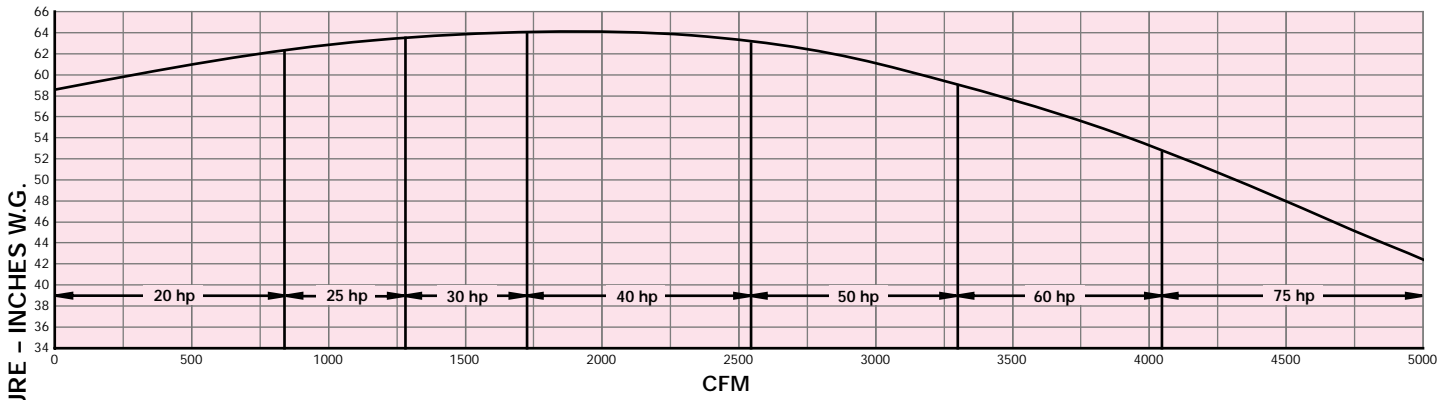

SIZE 29" — 10"

29" Wheel Dia. — 10" Outlet

3500 RPM

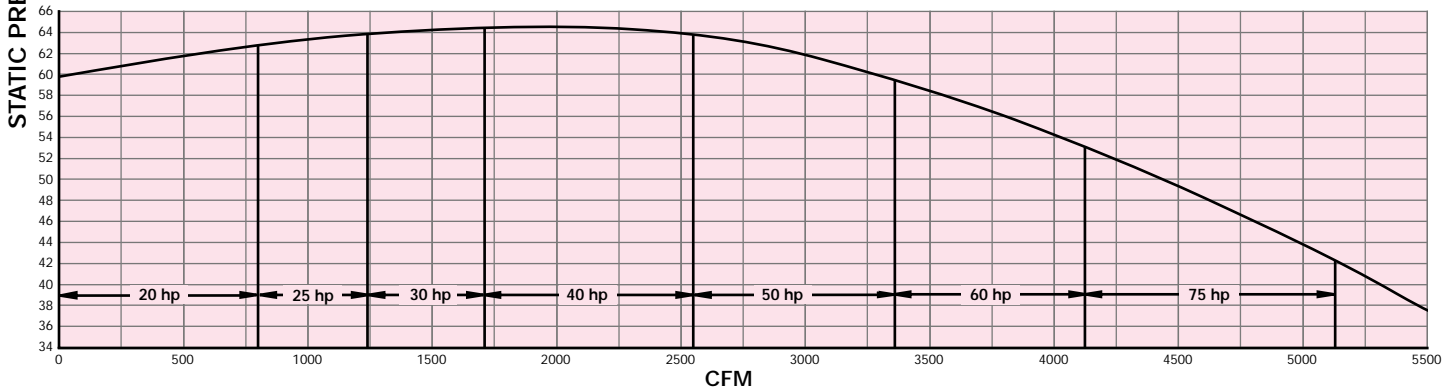

SIZE 29" — 12"

29" Wheel Dia. — 12" Outlet

3500 RPM

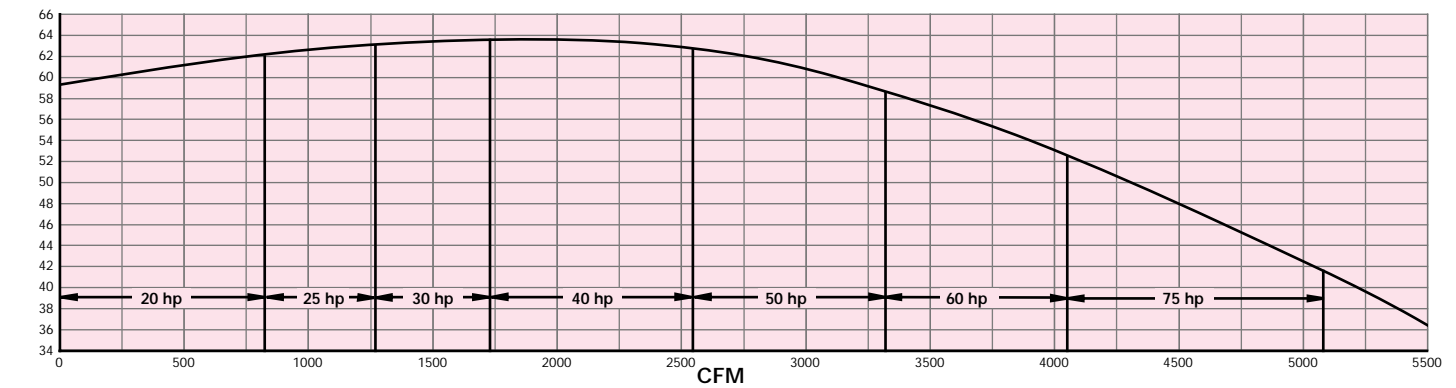

Performance shown is for installation Type D: Ducted inlet, ducted outlet.
Performance ratings do not include the effects of appurtenances in the airstream.

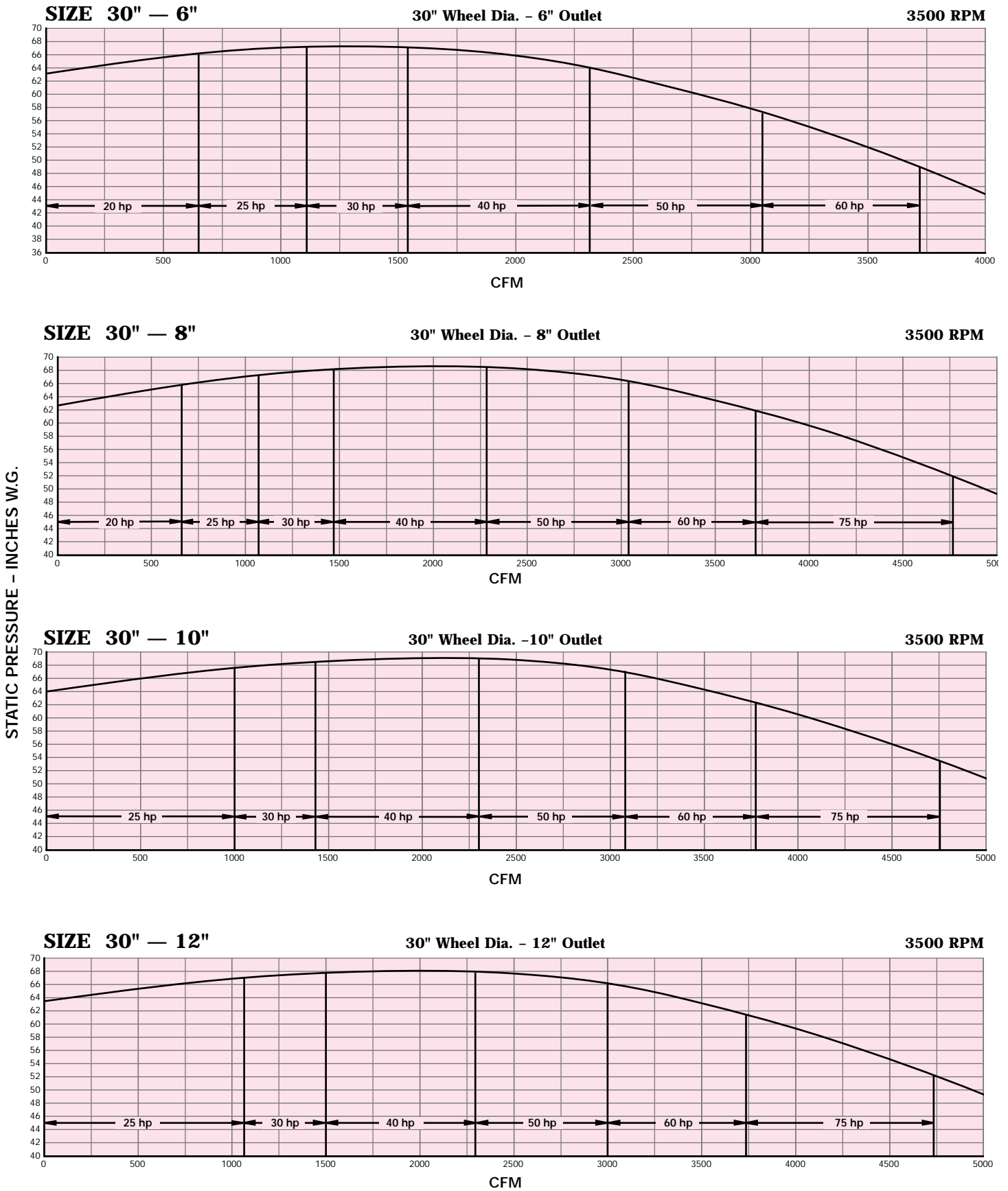

Performance shown is for installation Type D: Ducted inlet, ducted outlet.
 Performance ratings do not include the effects of appurtenances in the airstream.

STATIC PRESSURE - INCHES W.G.

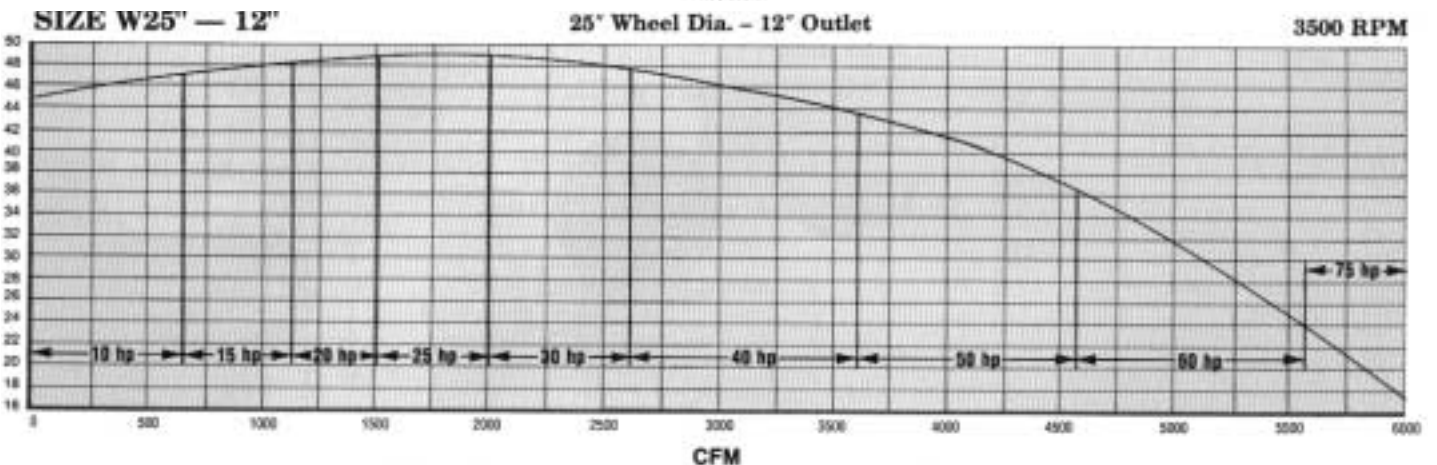
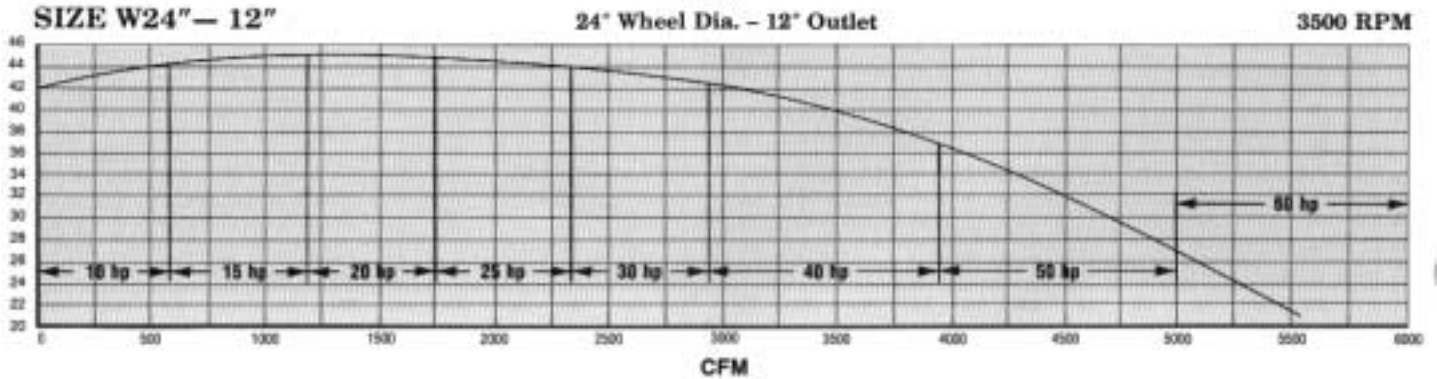
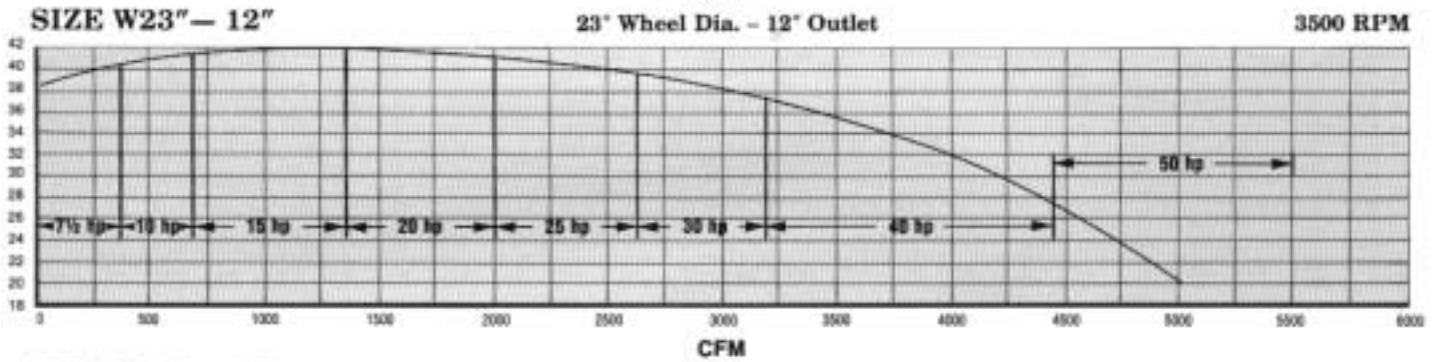
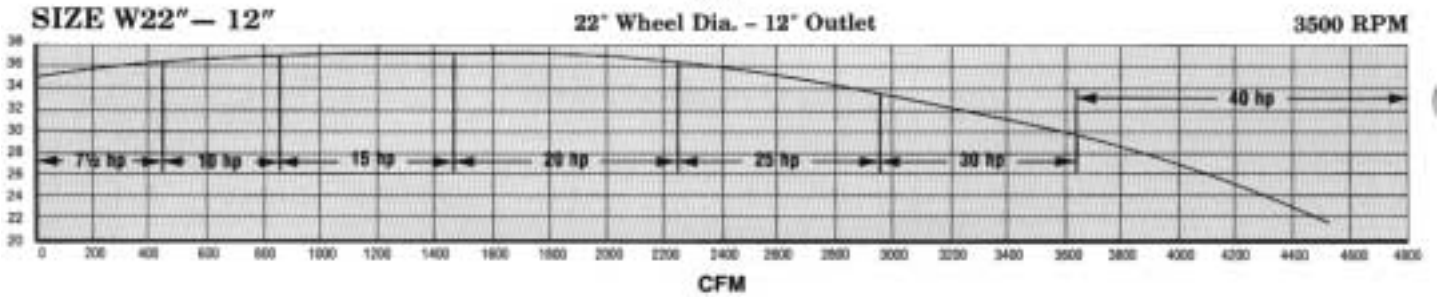
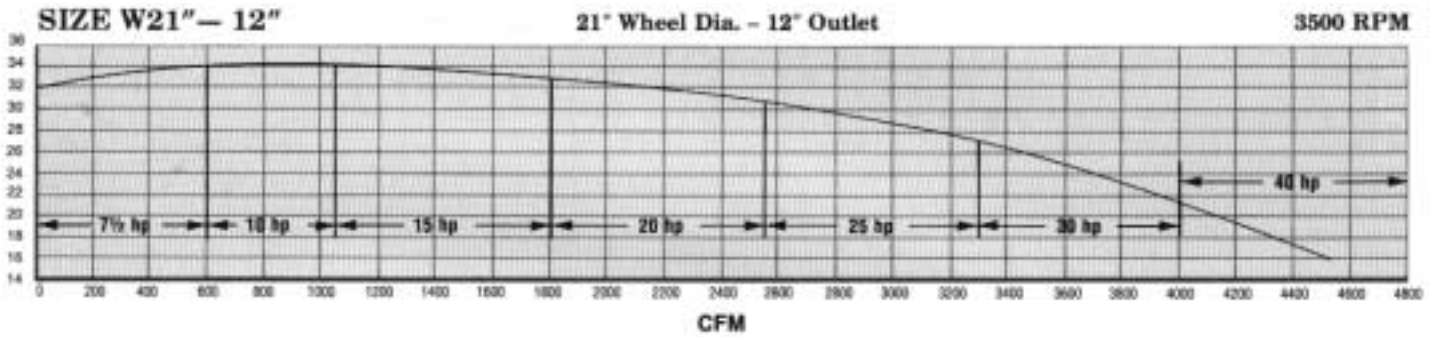

Performance shown is for installation Type D: Ducted inlet, ducted outlet.
 Performance ratings do not include the effects of appurtenances in the airstream.

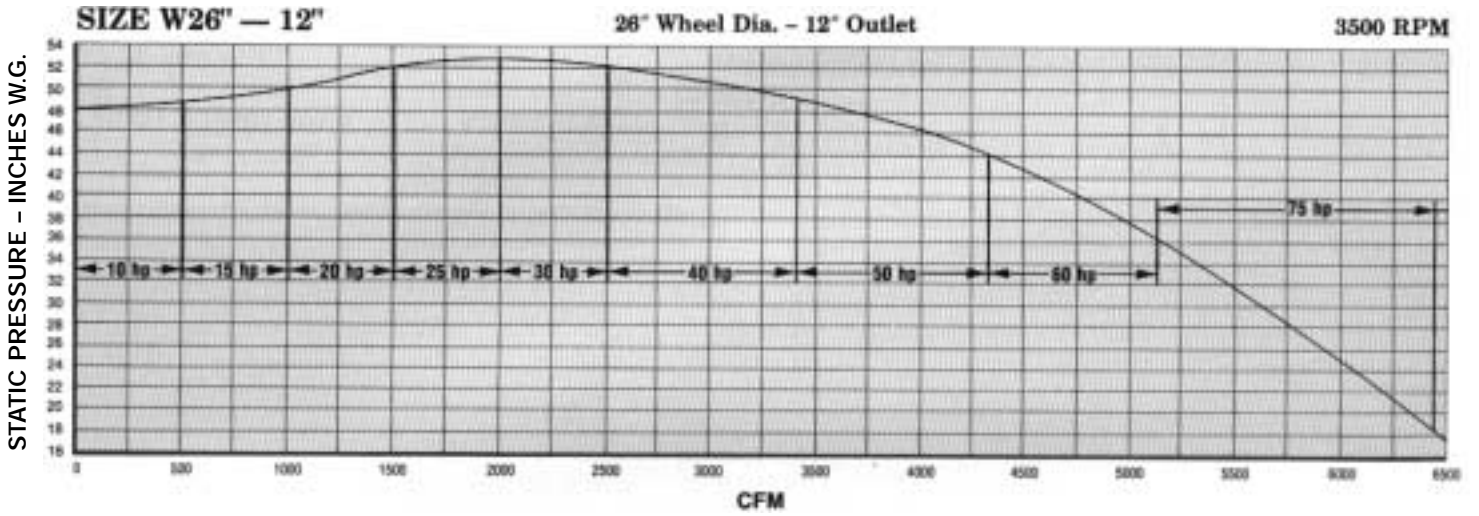

Performance shown is for installation Type D: Ducted inlet, ducted outlet.
 Performance ratings do not include the effects of appurtenances in the airstream.

Material Specifications for Standard Units

SIZE	HOUSING			MOTOR BASE		ALUMINUM WHEEL		STEEL WHEEL		MIN. MOTOR HP*
	SIDE PLATES	SCROLL BACK & SIDES	FRAME REINFORCEMENT	PLATE	BASE REINFORCEMENT	WEIGHT (LB)	WR ² (LB-FT ²)	WEIGHT (LB)	WR ² (LB-FT ²)	
14"	0.1350"	0.135"	0.25" x 2"	0.250"	0.25" x 2"	8.4	1.4	25.2	4.2	1½
15"						8.9	1.7	26.7	5.1	3
16"						9.4	2.1	28.2	6.3	3
17"						10.5	2.6	31.5	7.8	5
18"						11.6	3.2	34.8	9.6	5
19"	0.1350"	0.135"	0.25" x 2"	0.250"	0.25" x 2"	11.6	3.1	34.8	9.3	5
21"						13.5	4.6	40.5	13.8	7½
22"						14.4	5.5	43.2	16.5	10
23"						14.0	6.0	42.0	18.0	10
24"	0.1875"	0.135"	0.25" x 2"	0.250"	0.25" x 2"	15.2	6.9	45.6	20.7	10
25"						16.2	8.0	48.6	24.0	10
26"						17.8	9.2	53.4	27.6	10
27"						34.6	18.5	104	55.6	25
28"						36.6	21.1	110	63.3	30
29"	0.1875"	0.135"	0.25" x 2"	0.250"	0.25" x 2"	38.6	23.8	116	71.6	30
30"						40.6	26.8	122	80.4	40
W21"						0.1875"	0.135"	0.25" x 2"	0.250"	0.25" x 2"
W22"	17.6	5.7	52.8	17.1	10					
W23"	18.0	6.8	54.0	20.4	10					
W24"	19.6	7.8	58.8	23.4	10					
W25"	21.4	9.1	64.2	27.3	10					
W26"	22.4	10.3	67.2	30.9	15					

*To overcome inertia of steel wheel.

Dimensional Data – Arrangement 1

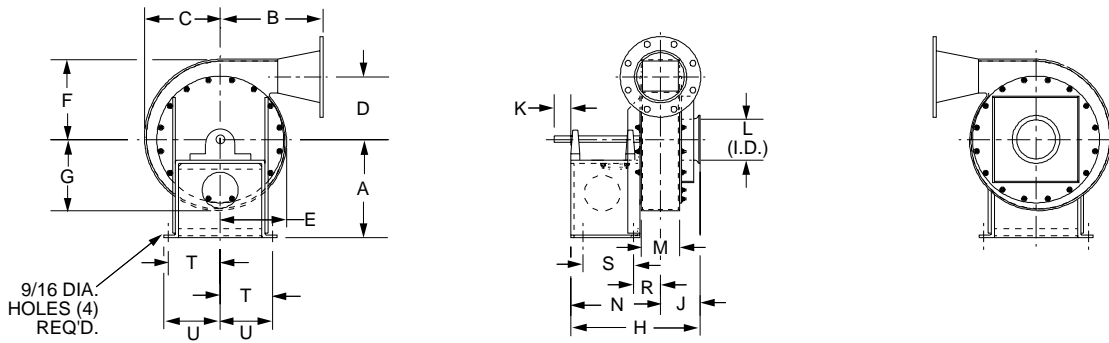

HSG. SIZE	WHL. SIZE	SHFT. DIA.	A	OUT. FLNGE		C	D	E	F	G	H	J	K	L	M	N	R	S	T	U	
				SIZE	B																
18"	14"	1 1/2	18 3/8	4"	17 3/4	12 7/16	10 9/16	10 13/16	13 3/16	11 11/16	23 3/4	7 1/2	3 1/2	6 5/8	6 1/4	17 1/4	4 1/4	12	8 3/4	9 5/8	
	15"			6"																	
	16"			8"																	
	17"																				
22"	19"	1 1/2	24 3/8	4"	17 3/4	16 5/8	14 3/4	14 1/2	17 5/8	15 5/8	23 3/4	6 1/2	4	6 5/8	6 1/4	17 1/4	4 3/8	12	11	11 7/8	
	21"			8"																	
	22"			10"																	21 3/4
26"	23"	1 1/2	26 7/8	6"	19	18 11/16	16 11/16	16 7/16	19 13/16	17 9/16	23 1/2	6 1/2	5	8	5 3/4	17	4 1/32	12	12 3/8	13 1/4	
	24"			8"																	
	25"			10"																	23
	26"			12"																	
30"	27"	2 3/16	30	6"	26 1/2	22 5/8	19 13/16	17 5/8	25 1/8	20 1/8	29 15/16	6 1/2	6	8	5 3/4	21 1/16	4 1/16	16	13 3/8	14 1/4	
	28"			8"																	
	29"			10"																	28 1/2
	30"			12"																	
W26"	W21"	1 15/16	26 7/8	12"	27	18 11/16	16 11/16	16 7/16	19 13/16	17 9/16	25 3/8	7 1/16	6	8	7 5/8	17 15/16	4 31/32	12	12 3/8	13 1/4	
	W22"																				
	W23"																				
	W24"																				
	W25"																				
W26"																					

Dimensional Data – Arrangement 4

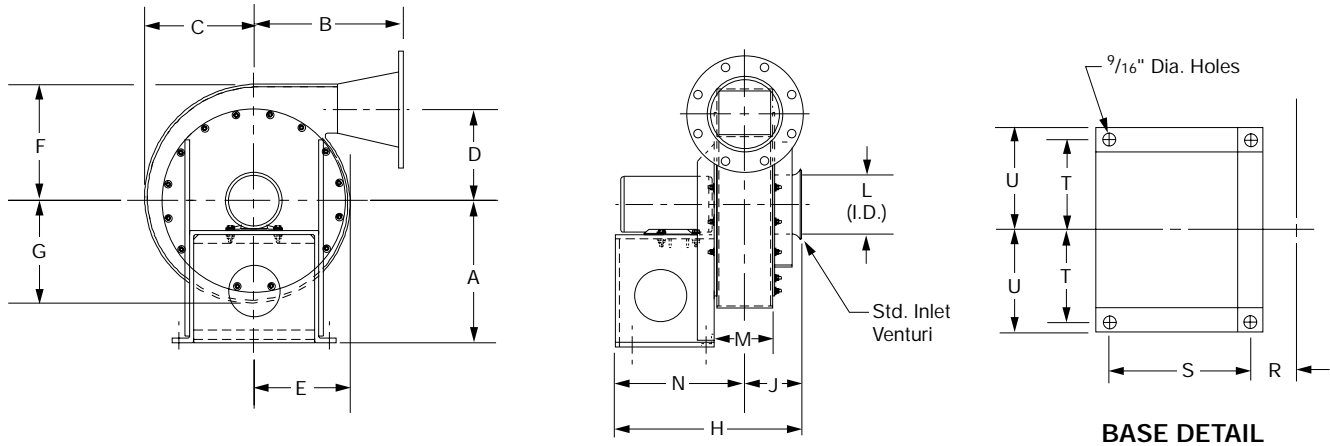

NOTES:

Flanged discharge is standard. Optional inlet flanges are available in any combination shown on page 24. Inlet flanges smaller than inlet venturi will require an optional pipe inlet (performance will be affected). Inlet flange will match discharge flange where possible, if not otherwise specified. All flanges match American Standard Class 125 drilling.

All dimensions in inches.

*CONSULT FACTORY FOR DOWNBLAST DISCHARGE DIMENSIONS.

HOUSING SIZE	WHEEL SIZE	OUTLET SIZE	B	C	D	E	F	G	J	L	M	N	R	S	T	U
18"	14"	4", 6"	17 1/4	12 7/16	10 9/16	10 13/16	13 3/16	11 11/16	6 1/2	6 5/8	6 1/4	18 1/2	4 1/4	13 3/4	8 5/8	9 1/2
	15"	4"														
	16"	6"														
	17"	8"														
	18"	8"														
22"	19"	4"	17 3/4	16 5/8	14 3/4	14 1/2	17 5/8	15 5/8	6 1/2	6 5/8	6 1/4	20 5/8	4 3/8	15 1/4	11	11 7/8
	21"	6"	21 3/4													
	22"	8"														
26"	23"	6"	19	18 11/16	16 11/16	16 7/16	19 13/16	17 9/16	6 1/2	8	5 3/4	24 5/16	4 7/8	18 1/2	12 3/8	13 1/4
	24"	8"	23													
	25"	10"														
	26"	10"														
	26"	12"														
30"	27"	6"	26 1/2	22 5/8	19 13/16	17 5/8	25 1/8	20 1/8	6 1/2	8	5 3/4	24 5/16	4 7/8	18 1/2	13 3/8	14 1/4
	28"	8"	28 1/2													
	29"	10"														
	30"	12"														
		12"														
W26"	W21"	12"	27	18 11/16	16 11/16	16 7/16	19 13/16	17 9/16	7 7/16	8	7 5/8	25 1/4	5 13/16	18 1/2	12 3/8	13 1/4
	W22"															
	W23"															
	W24"															
	W25"															
	W26"															

HOUSING SIZE	MOTOR FRAME	A	H	
			OPEN MOTOR	ENCLOSED MOTOR
18"	143T & 145T	16 5/8	25	25
	182T & 184T	17 5/8		
	213T	18 3/8		
	215T			
22"	143T & 145T	21 5/8	27 1/8	27 1/8
	182T & 184T	22 5/8		
	213T & 215T	23 3/8		
	254T	24 3/8		
	256T			
26"	182T & 184T	25 1/8	30 13/16	30 13/16
	213T & 215T	25 7/8		
	254T & 256T	26 7/8		
	284TS	27 5/8		
	286TS			
	324TS			
	326TS			

HOUSING SIZE	MOTOR FRAME	A	H	
			OPEN MOTOR	ENCLOSED MOTOR
30"	254T & 256T	29 7/8	30 13/16	30 13/16
	284TS & 286TS	30 5/8		
	324TS & 326TS	31 5/8		
	364TS & 365TS	32 5/8		
W26"	213T & 215T	25 7/8	32 11/16	32 11/16
	254T & 256T	26 7/8		
	284TS	27 5/8		
	286TS			
	324TS	28 5/8		
	326TS			
	364TS			
365TS	29 5/8			

Dimensional Data – Arrangement 8

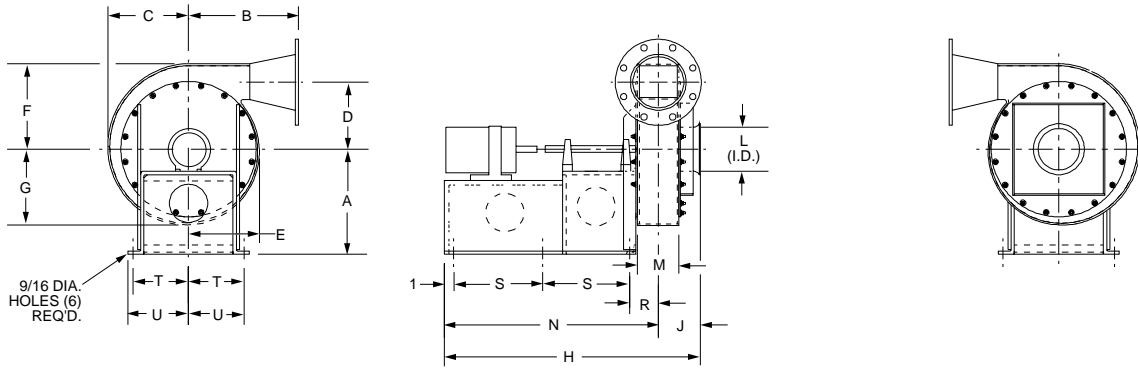

HSG SIZE	WHL SIZE	SHFT DIA	A	OUT. FLNGE SIZE		C	D	E	F	G	J	L	M	R	T	U	
				SIZE	B												
18"	14"	1 1/2	18 3/8	4"	17 1/4	12 7/16	10 9/16	10 13/16	13 3/16	11 11/16	6 1/2	6 5/8	6 1/4	4 1/4	8 3/4	9 5/8	
	15"			6"													
	17"			8"													
	18"																
22"	19"	1 1/2	24 3/8	4"	17 3/4	16 5/8	14 3/4	14 1/2	17 5/8	15 5/8	6 1/2	6 5/8	6 1/4	4 3/8	11	11 7/8	
	21"			6"													
	22"			8"													
				10"													21 3/4
26"	23"	1 1/2	26 7/8	6"	19	18 11/16	16 11/16	16 7/16	19 13/16	17 9/16	6 1/2	8	5 3/4	4 1/32	12 3/8	13 1/4	
	24"			8"													
	25"			10"													23
	26"			12"													
30"	27"	2 3/16	30	6"	26 1/2	22 5/8	19 13/16	17 5/8	25 1/8	20 1/8	6 1/2	8	5 3/4	4 1/16	13 3/8	14 1/4	
	28"			8"													
	29"			10"													28 1/2
	30"			12"													
W26"	W21"	1 15/16	26 7/8	12"	27	18 11/16	16 11/16	16 7/16	19 13/16	17 9/16	7 7/16	8	7 5/8	4 31/32	12 3/8	13 1/4	
	W22"																
	W23"																
	W24"																
	W25"																
	W26"																

Flange Dimensions

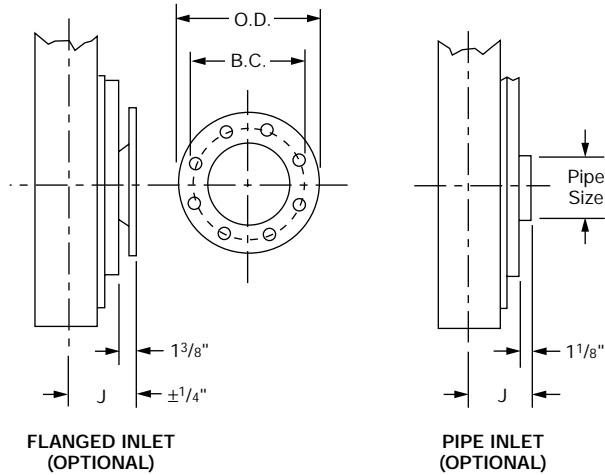

FLANGE DIMENSIONS					
INLET/DISCHARGE SIZE	I.D.	O.D.	BOLT CIRCLE	HOLES	
				NO.	SIZE
4"	4	9	7 1/2	8	3/4
6"	6	11	9 1/2	8	7/8
8"	8	13 1/2	11 3/4	8	7/8
10"	10	16	14 1/4	12	1
12"	12	19	17	12	1

Standard Pipe Sizes Offered:
 6 5/8" O.D. on 18" and 22" housings
 8 5/8" O.D. on 26", 30" and W26" housings.
 Others sizes available upon request.

Discharge Arrangements

DISCHARGE POSITION		TOP HORIZONTAL	BOTTOM HORIZONTAL	UPBLAST	TOP 45° DOWN	BOTTOM 45° UP	TOP 45° UP
ROTATION	CLOCK-WISE *						
	COUNTER-CLOCK-WISE *						

*SPECIAL CONSTRUCTION IS REQUIRED FOR CLOCKWISE AND COUNTERCLOCKWISE DOWNBLAST POSITIONS.

Typical Specifications

Fans shall be Model HPB High Pressure Centrifugal Blowers as manufactured by Aerovent, Minneapolis, Minnesota, and shall be of the size and capacity as indicated in the fan schedule. Model HPB High Pressure Blowers shall be tested and certified in accordance with ANSI/ASHRAE 51-1985 and ANSI/AMCA 210-85 test codes and guaranteed by the manufacturer to deliver the rated, published performance levels. In addition, each unit shall be factory test run prior to shipment.

CONSTRUCTION — The Model HPB High Pressure Blower shall have a continuously welded heavy-gauge steel housing and motor base for rugged, heavy duty service. All sizes shall have rotatable and reversible housing, inlet venturi with a guard, and all-welded heavy duty flanged discharge drilled to match American Standard Class #125 bolt pattern. A flanged or piped inlet is available as an option.

WHEEL — The Model HPB High Pressure Blower shall be furnished with an aluminum alloy wheel. Wheel sizes 14" through 26" shall be a riveted construction, while wheel sizes 27" to 30" shall be welded. The wheel shall be dynamically and statically balanced and shall be attached to the shaft with a split-taper lock bushing for easy removal from the shaft. Welded steel wheels are available for heat applications (temperatures 300°F to 600°F).

BEARINGS (Arr. 1, 8 only) — Bearings shall be of a regreasable pillow block type, and shall have a minimum L-10 life as defined by AFBMA of at least 20,000 hours (100,000 hours average life).

DRIVES (Arr. 1, 8 only) — Belts and sheaves furnished by the manufacturer shall be designed with a 1.4 service factor unless otherwise specified. Sheaves shall be cast iron with static conducting belts. The adjustment of the belt tension is accomplished with an adjustable motor base.

MOTORS — Motors shall be foot-mounted NEMA Design B, standard industrial, continuous duty, ball bearing, variable torque type suitable for operation on voltage, phase, and hertz, as listed in the fan schedule. Motor bearings shall have a minimum L-10 life, as defined by AFBMA, of at least 40,000 hours (200,000 hours average life).

BALANCING — The wheel assembly shall be statically and dynamically balanced in accordance with ANSI/AMCA 204-96 "Balance Quality and Vibration Levels for Fans" to Fan Application Category BV-3, Balance Quality Grade G6.3. In addition, direct drive fan wheels shall be balanced on the motor shaft, belt driven fan wheels shall be balanced on the fan shaft after final assembly in the fan casing, in the manufacturing facility, to the following peak velocity values, filter-in, at the fan test speed:

<u>Fan Application Category</u>	<u>Rigidly Mounted (in./s)</u>	<u>Flexibly Mounted (in./s)</u>
BV-3	0.15	0.20

FINISH — The unit, after fabrication, shall be cleaned and chemically pretreated by a phosphatizing process and shall be painted inside and outside with an air dry enamel. The fan shall be coated with the following optional finish:

- | | |
|--|--|
| <input type="checkbox"/> Plasite 4310 – Vinyl Ester | <input type="checkbox"/> Plasite 7122L/Heresite VR506 – Epoxy Phenolic |
| <input type="checkbox"/> Plasite 3066 – Baked Phenolic | <input type="checkbox"/> Farboil – Baked Aromatic Epoxy |
| <input type="checkbox"/> Air Dried Epoxy | <input type="checkbox"/> Carbocoat 30 (replaces Carbolene 3358/Sanitile 550) |

SOUND POWER LEVELS — The sound power level of the fans shall not exceed:

Octave Band - CPS (Sound Power 10⁻¹²)

20-75	75-150	150-300	300-600	600-1200	1200-2400	2400-4800	4800-10000

ACCESSORIES — The units shall be furnished complete with:

- | | |
|--|---|
| <input type="checkbox"/> Spark Resistant Construction (Type A or B) | <input type="checkbox"/> Outlet Dampers |
| <input type="checkbox"/> Shaft & Bearing Guard | <input type="checkbox"/> Continuous Double-Welded Scroll |
| <input type="checkbox"/> Belt Guard | <input type="checkbox"/> Inlet Filter |
| <input type="checkbox"/> Coupling Guard | <input type="checkbox"/> Inlet Combination Filter/Silencer |
| <input type="checkbox"/> Inlet Flange | <input type="checkbox"/> Inlet/Outlet Silencer |
| <input type="checkbox"/> Tube Adapter (Inlet/Outlet) | <input type="checkbox"/> Outlet Silencer |
| <input type="checkbox"/> Flexible Connector (Inlet/Outlet) | <input type="checkbox"/> High Temperature Welded Steel Wheel |
| <input type="checkbox"/> Wheel Thrust Vanes | <input type="checkbox"/> Unitary Base |
| <input type="checkbox"/> Shaft Seal (Elastometric Rotary, Ceramic Felt, Lubricated, or Stuffing Box) | <input type="checkbox"/> Vibration Isolators (Spring or R.I.S.) |