



ENGINEERING DATA

Aerovent • TC Ventco • Fiber-Aire • Twin City Fan & Blower • TC Axial • Clarge

Fan Performance Troubleshooting Guide

Introduction

Trying to determine why a fan is not working the way you want it to can sometimes be a very confusing and frustrating experience. This document, based on our experience, was put together to help fan users diagnose and troubleshoot fan performance problems.

How Fan Systems Work

Before getting into troubleshooting it is worth our while to look at how fans and duct systems work together. A duct system's design affects how a fan operates; how the fan is selected affects how the duct system functions. Fans operate on all kinds of different duct systems, ranging from no ductwork at all (mancoolers and panel fans) to those with short simple runs of ductwork to systems with long complicated runs of ductwork, and finally to completely shut off systems (where the purpose is only to generate pressure). The longer and more complicated the ductwork gets, the more resistance to flow there is.

When fans are tested in a laboratory, they are tested under conditions that simulate the extremes of no resistance, complete resistance (no flow at all), and everything in between. Figure 1 shows the test points of a typical fan operating at constant speed and at standard air density. The flow rate is plotted on the horizontal axis, the fan static pressure is plotted on the lower vertical axis, while the top vertical axis shows the brake horsepower. The point labeled A₁ simulates a duct system where there is no resistance flow since the static pressure is zero. This point is sometimes referred to as "wide open volume" or "free delivery." Point A₂ shows the brake horsepower measured at this point. Brake horsepower is the power required at the fan shaft. It does not include losses associated with the motor or belt drives.

Points B through F are generated by increasing the resistance to flow. In the laboratory, closing a damper does this. Connecting the test points generates the fan performance curve. Point F is the point where the fan delivers no airflow and is purely generating pressure. This point is sometimes referred to as "shut off" or "no delivery."

Once the performance of a fan at a given speed is established, it is possible to predict the performance at other speeds or other air densities using a set of equations known as the fan laws. The first fan law states that the change in flow rate is proportional to the change in speed. This can be written as:

$$Q_N = Q_O \times \left(\frac{RPM_N}{RPM_O} \right)$$

where: Q = volumetric flow rate (CFM)
 RPM = fan speed in revolutions per minute
 N = new conditions
 O = old conditions

Figure 1. Test Points at Constant Speed and Standard Air Density

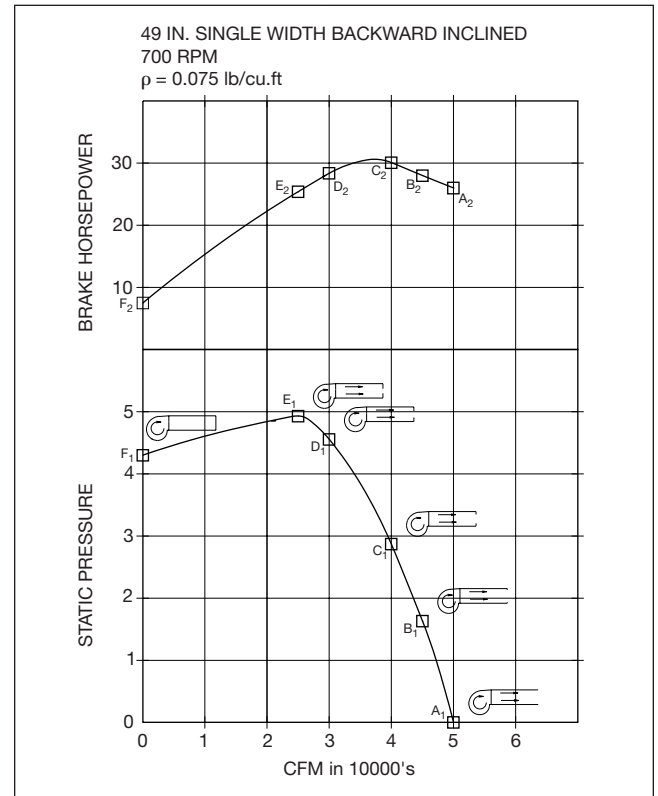

The second fan law states that the change in pressure is proportional to the square of the change in speed:

$$P_N = P_O \times \left(\frac{RPM_N}{RPM_O} \right)^2 \times \frac{\rho_N}{\rho_O}$$

where: P = pressure (in. w.g.)
 ρ = air density (lb/cu.ft)

The change in the power requirement is proportional to the cube of the change in speed, as shown in the equation of the third fan law:

$$Hp_N = Hp_O \times \left(\frac{RPM_N}{RPM_O} \right)^3 \times \frac{\rho_N}{\rho_O}$$

where: Hp = fan power requirement (hp)

Figure 2 shows the same fan as Figure 1 with the performance calculated at different fan speeds.

The fan laws show that the pressure and horsepower change with density but the flow rate stays the same. This is why fans are sometimes referred to as constant volume machines. But because the pressure and horsepower change with air density, it is important to select fans for the proper operating conditions. When testing fans, it is important to correct the test data for density effects and to make sure when comparing test data to the design data that they are both at the same density. Figure 3 shows the performance of the same fan as Figure 1 at standard air density (0.075 lb/cu.ft) and at an elevation of 5,000 feet above sea level where air weighs 0.059 lb/cu.ft.

Figure 2. Test Points at Different Speeds and Standard Air Density

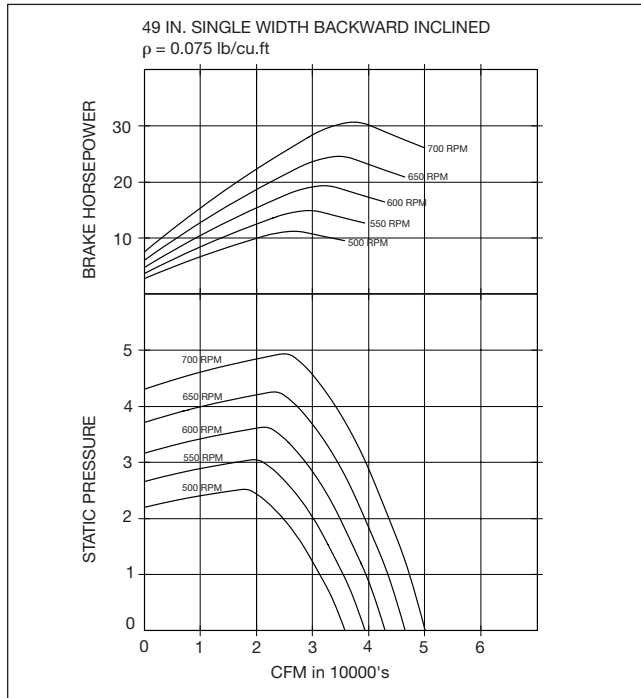
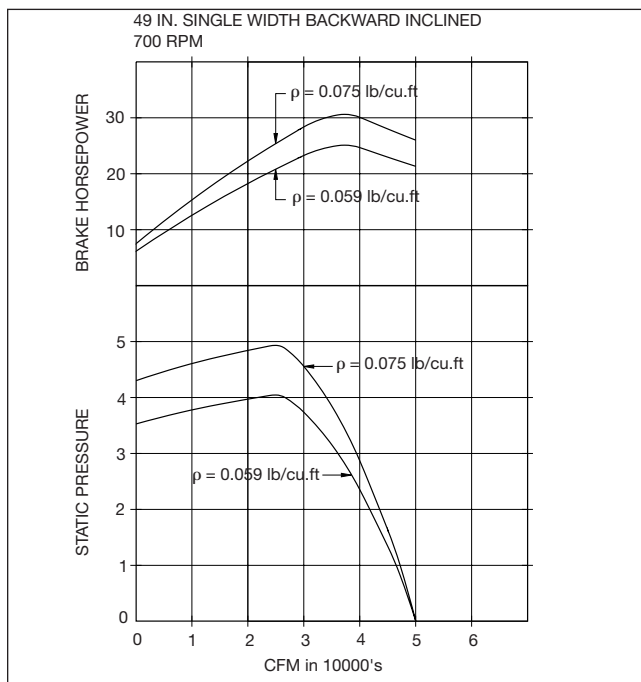

Figure 3. Test Points at Different Air Densities



How Systems Work

It makes sense to say that more pressure is required if you want to move more air through your duct system. You can feel this when you try to blow more air through a straw. How the airflow varies with pressure is a function of how the air flows through the duct system.

For the vast majority of duct systems, the air flowing in the ducts is turbulent. Turbulent flow is characterized by rapid, random fluctuations of velocity and pressure. With turbulent flow, the relationship between the flow rate and the pressure is as follows:

$$P_1 = P_2 \times \left(\frac{Q_1}{Q_2}\right)^2$$

where: P_1 = pressure at point 1
 P_2 = pressure at point 2
 Q_1 = flow rate at point 1
 Q_2 = flow rate at point 2

This equation defines a system resistance curve, which is usually referred to as a "system line." As long as the duct system remains constant (no dampers changing, filters getting dirty, etc.) the pressure required to achieve different flow rates will follow this line.

Example: A duct system requires 2 in. w.g. in order to have a flow rate of 20,000 CFM. What pressure is required if we want the flow rate to increase to 30,000 CFM?

Using the equation above:

$$P_1 = 2 \times \left(\frac{30000}{20000}\right)^2 = 4.5 \text{ in. w.g.}$$

Figure 4 shows these two points along with the system line that is defined by them. If the flow remains turbulent (and it almost always does) and if the duct configuration does not change (including the position of any dampers), the pressure required for a given flow rate will follow this line. Some variable air volume (VAV) systems require a minimum pressure at the end of the duct runs in order for the VAV boxes to open. No flow occurs until this pressure is reached. The system line equation for this type of system is:

$$P_1 = P_0 + (P_2 - P_0) \times \left(\frac{Q_1}{Q_2}\right)^2$$

where P_0 = pressure required to have flow

Figure 4. Two Performance Points Along the System Curve

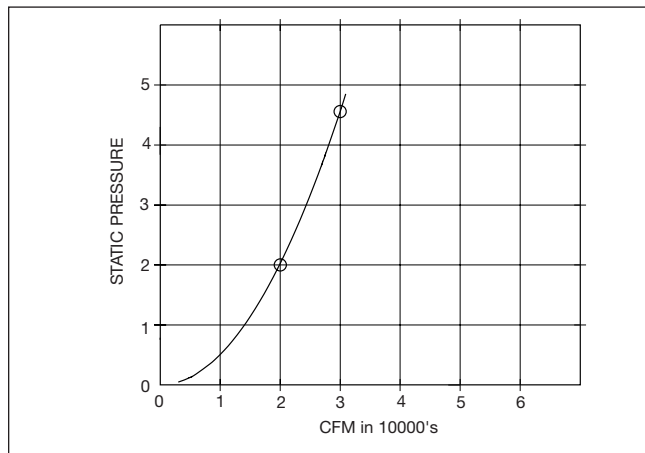
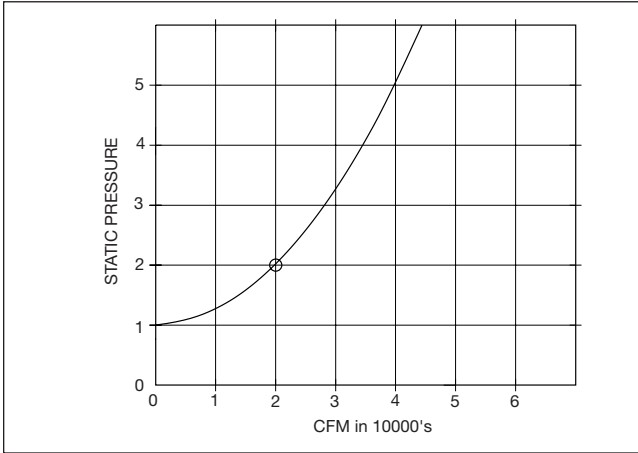

Figure 5 shows this type of system passing through a design point of 20,000 CFM at 2 in. w.g. and a VAV box requirement of 1 in. w.g.

Figure 5. Variable Air Volume System Curve



How Fans and Systems Work Together

A fan will operate at the point where the system line intersects the fan curve. To generate the different test points shown in Figure 1, the system resistance had to change. Remember that at Point A₁ there is no resistance to flow and that the resistance to flow was increased as we moved towards F₁. As a result each test point has a unique system resistance curve associated with it, as shown in Figure 6. In fact, there are an infinite number of system lines between points A₁ and F₁.

Figure 6. System Resistance Curves

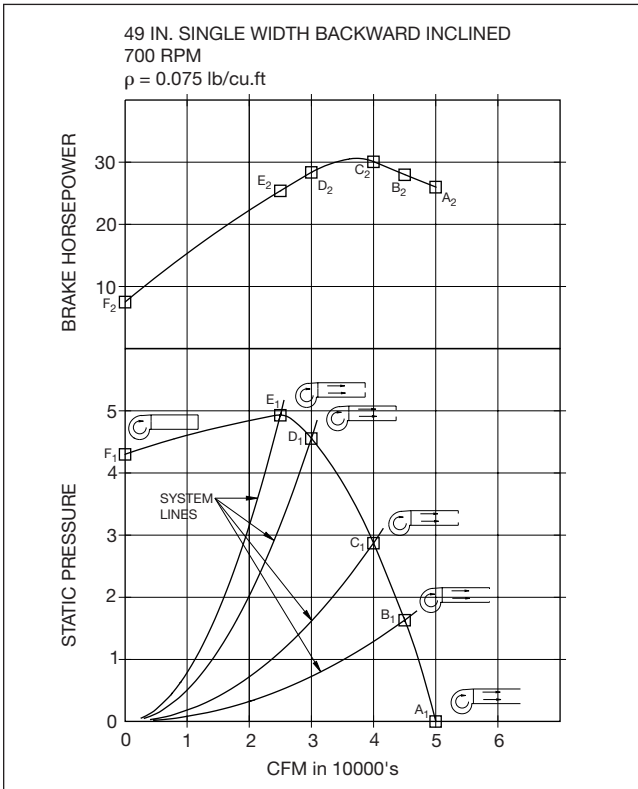

Even though a fan is selected and sold to deliver a specified flow rate at a specified static pressure and speed, all the fan manufacturer can be sure of is that the point of operation will lie somewhere on the fan curve (sometimes even this is in doubt depending on the duct geometry, which will be explained later). Where along the fan curve the operating point lies depends entirely on the ductwork. The fan will operate at the place where the system line intersects the fan curve.

System Effects

Most of the time fans are tested with open inlets, and designs that do not have an integral inlet bell will be tested with one to simulate inlet ductwork. Figure 7 shows the streamlines the air follows as it enters a fan with a well-designed inlet bell and with a straight run of duct upstream of the fan. The airflow is smooth and the velocity at the entrance is uniform.

Figure 7. Air Streamlines at Fan Inlets

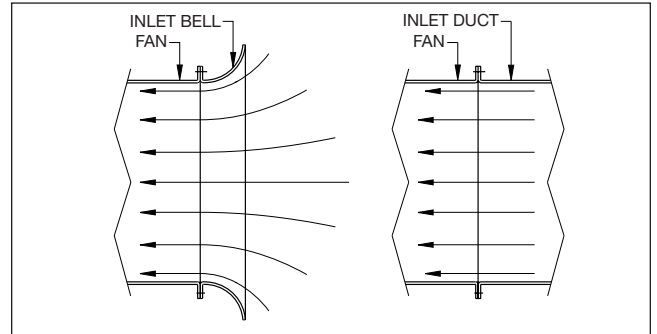

The velocity profile coming out of even the most efficient fans is not uniform. Especially on centrifugal fans there are regions of high velocity air coming out of the impeller. Figure 8 shows typical outlet velocity profiles for centrifugal and axial fans.

Figure 8. Typical Outlet Velocity Profiles

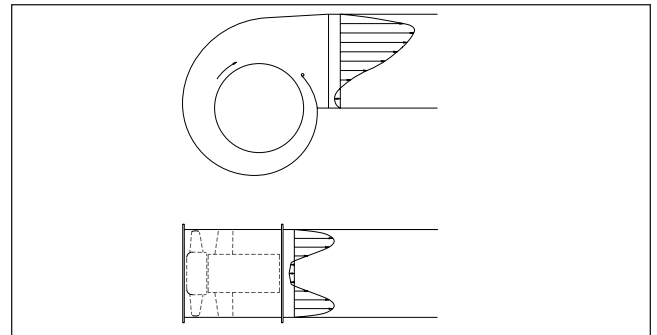

A length of straight duct is required at the outlet to allow the high velocity (kinetic energy) to be converted to static pressure (potential energy). To get full pressure conversion, a duct at least as long as the 100% effective duct length is required. AMCA defines the 100% effective duct length to be a minimum of two and one half equivalent duct diameters for outlet velocities up to 2,500 fpm, with 1 duct diameter added for each additional 1,000 fpm. Also it is important that the outlet connection be smooth. In the test code, AMCA specifies that the area of the outlet duct be between 95% and 105% of the fan outlet area and that any transitions used have sides that are sloped no more than 15° on converging sections and 7° on diverging sections.

Duct fittings or fan installations that do not provide smooth, uniform flow at the fan inlet or complete pressure recovery at the fan outlet cause the fan to perform at a level below its catalog rating. Elbows cause non-uniform airflow at

the fan inlet. More air enters the fan at the outside of the elbow than at the inside. Figure 9 shows what happens to a centrifugal fan's performance curve first when an elbow is located at its inlet, and second when an elbow is located at the inlet and there is no outlet duct. This loss in performance is known as system effect.

Figure 9. System Effects Curves

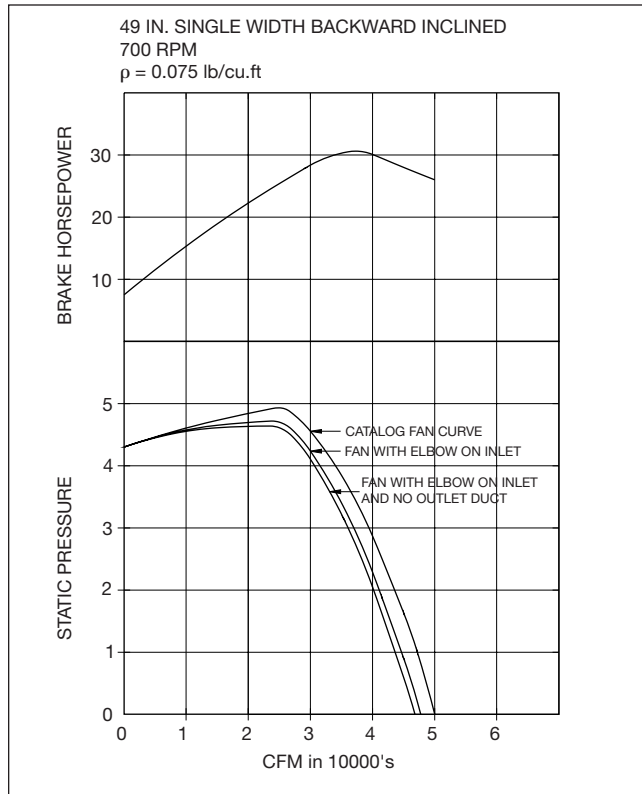

Duct configurations that cause system effects should be avoided whenever possible. To help in those situations when it is unavoidable, AMCA Publication 201 contains methods of estimating the system effects for some of the most common situations. A series of tests were run in AMCA's laboratory. Although variations due to factors such as fan type and design were observed, figures showing system effect factors were put together to allow fan users to estimate system effects.

The system effect factor must be added to the system design pressure to select the fan and determine the required speed and horsepower. The system effect will cause the fan to generate only the system design pressure, not the pressure that the fan was selected for.

Inlet System Effects

Elbows mounted near the inlet of a fan are the most common inlet system effect. Elbows should be installed at least three equivalent duct diameters upstream of a fan inlet. Not only do elbows mounted closer cause a system effect but they can also cause pressure fluctuations, increased sound levels, and structural damage to the fan.

As depicted in the previous example, elbows at a centrifugal fan's inlet cause a system effect. Often the elbow at the inlet is not a true elbow, but a drop box as illustrated in Figure 10. The system effect for this type of inlet elbow is nearly impossible to predict, as it is a function of fan type, inlet size, and box width and depth. Losses in flow rate as high as 45% have been observed with this type of inlet. Most fans can be purchased with an optional inlet box as shown in Figure 11. These boxes are designed to have minimal and predictable system effects.

Figure 10. Drop Box

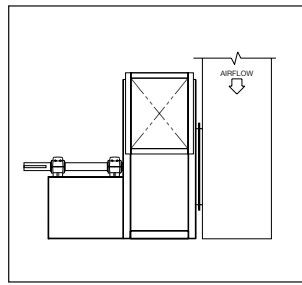
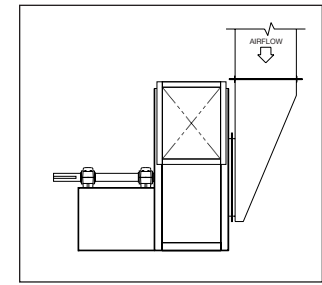
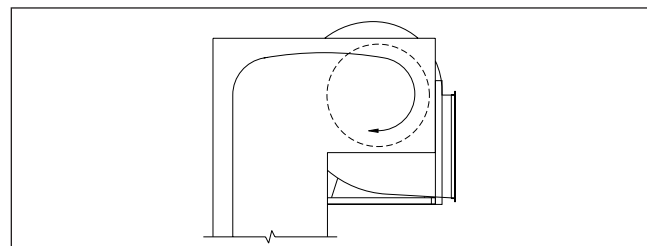

Figure 11. Inlet Box



Often the duct configuration can cause an airflow pattern that is detrimental to fan performance. Figure 12 shows one example of a duct configuration that causes the air to spin in the direction opposite the impeller rotation (counter rotating swirl). When this happens there may be a slight increase in pressure produced by the fan, but with a significant increase in horsepower.

Figure 12. Duct Configuration Causing Counter Rotating Swirl



Similar duct configurations can cause the air to spin in the direction of impeller rotation (pre-rotating swirl). This reduces the pressure produced, and the power consumed by the fan. Inlet vanes produce this effect to control flow with horsepower savings. Like drop boxes, the severity of the system effect caused by counter rotating and pre-rotating spin is impossible to predict. Avoid duct configurations that have the potential to cause spin.

Figure 13 shows how straightening vanes placed in the elbows can minimize system effect. If there is room, straighteners added to the duct just upstream of the fan inlet will break up spinning air. Case Studies 2 and 4 in the following section demonstrate how straighteners can solve performance problems.

Figure 13. Straightening Vanes

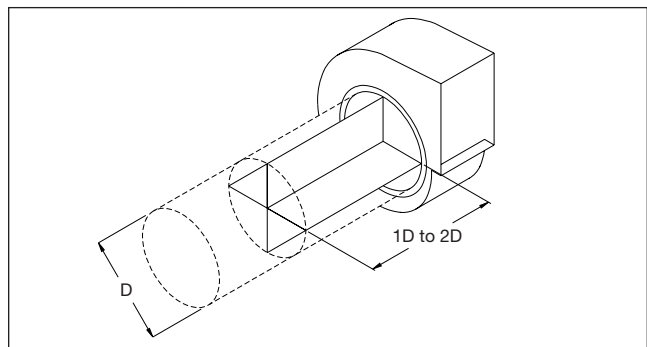

Ductwork sized smaller than the fan inlet, butterfly valves and belt guards placed too close to the fan inlet are two examples of obstructions that cause system effects. Fan inlets located too close to a wall cause non-uniform flow and a resulting system effect.

Outlet System Effects

The most common cause of system effects on fan outlets is an insufficient length of straight duct length that prevents the full conversion of velocity to static pressure. As defined previously, the length of straight duct length required is the 100% effective duct length. Many of the charts in AMCA Publication 201 use the blast area, which is the outlet area minus the area of the cut off. The blast area is not normally included in catalog performance data but is shown in Table 1 as a percentage of outlet area for various fan types.

Table 1. Blast Area

FAN TYPE	BLAST AREA ÷ OUTLET AREA
BI & AF SWSI	0.80
BI & AF DWDI	0.77
INDUSTRIAL FANS	1.00
RADIAL TIP FANS	1.00
FC DWDI	0.61

The charts in Publication 201 show that tubeaxial fans do not have a system effect curve for no outlet duct. Tests at AMCA indicated very little loss in performance with tubeaxial fans without outlet ducts and with vaneaxial fans with outlet ducts as short as 50% effective duct length.

Elbows are frequently mounted close to fan outlets. This placement will disrupt the energy conversion from velocity pressure to static pressure. As with short ducts, tests indicate that the factors are negligible with tubeaxial fans and greater with centrifugal fans than with vaneaxial fans. The position of the elbow influences how great the system effect is with centrifugal fans. When the elbow follows the curvature of the scroll, as in position B in Figure 14, the system effect is minimized, but when the elbow goes against the curvature of the scroll as in position C the effect is worsened. Not all system effects are bad. Frequently, cones or rectangular transitions called *evasés* are added to fan outlets to increase the amount of static pressure regain over what is possible with a straight duct section that matches the outlet area. The increase in pressure can be estimated using the static pressure regain for expansion calculation, or corrected performance data can be obtained from the manufacturer.

Figure 14. Elbow Positions

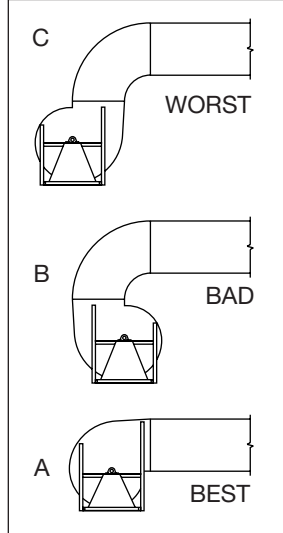

Manufacturing and Testing Tolerances

Most fans are fabricated metal assemblies and there are slight differences from one fan to the next. These variances could be due to manufacturing tolerances, welding distortion, or assembly tolerances. These small differences may have a slight effect on how the fans perform.

In addition to the differences due to manufacturing, there are uncertainties in the performance of a fan due to testing tolerances or errors. Even when tested in the laboratory there are variations in the readings that can contribute to test error. Sources of these variations can be due to the instruments or due to the test setup.

Periodically instruments need to be calibrated. The reading an instrument gives often drifts or changes over long periods of time. When an instrument is calibrated, its measurements are compared to a standard that is traceable to the National Bureau of Standards. In order to get more accurate

results, a calibration correction is frequently applied to the reading the instrument gives. If the period of time since the instrument was calibrated is too long, the instrument is out of calibration, and there is a greater chance for the instrument to give a reading that varies slightly from the “true” reading. Because the air flowing through fans is turbulent, the readings vary over time. These variations must be averaged, either electronically or visually. How accurately the averaging is done affects the uncertainty of the reading.

Air density corrections usually have to be made. Catalog performance is based on standard air density, which is 0.075 lb/cu.ft. This corresponds with air at 70°F at sea level and a relative humidity of 50%. Air density calculations require readings of barometric pressure, wet bulb temperature, dry bulb temperature, and elevation above sea level. If the fan handles a gas other than air, the composition of the gas must be known in order to make the appropriate air density corrections. The care and precision in taking these measurements and the subsequent calculations affect the accuracy of the test data.

An association of fan manufacturers, the Air Movement and Control Association (AMCA), has set standards for the industry. They have standards that specify how fans are to be tested in the laboratory. They also have established a certified ratings program. Part of the certified ratings program requires that a fan line’s performance is tested periodically in an independent laboratory. The test results must be within a certain tolerance of the catalog rating. This tolerance, shown in Figure 15, takes into account the manufacturing variances and the variances expected when testing a fan in two laboratories.

Figure 15. Field Test vs. Catalog Performance

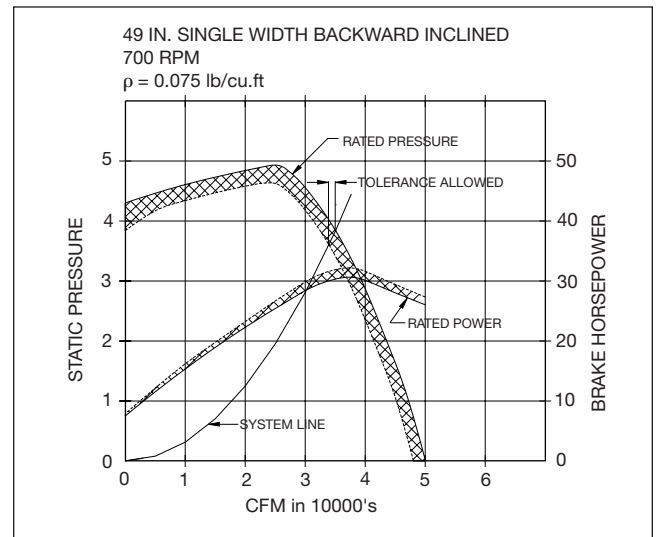

There is a tendency to compare the performance along lines of either constant pressure or constant volume. This is not the correct way. Notice that the tolerance for flow and pressure is based on a system line. This is done because that is how fans and duct systems interact. The tolerance varies with the location of the fan curve, but corresponds to a change in fan speed of approximately 3%. If the fan test results are within the shaded region, the fan is operating within acceptable limits to its performance curve. The tolerances shown in Figure 15 are based on laboratory testing. Field testing is rarely as accurate as laboratory testing.

Fans in the laboratory are tested under ideal conditions. The inlet conditions provide for smooth entry of air into the fan and straight ductwork on the discharge allows static pressure regain. Such ideal conditions in the field are the exception rather than the norm and as a result most fans in the field do not perform as well as they do in the laboratory. The labora-

tory test setup must meet strict requirements. Duct connections must exactly match the fan. If transitions are used, they must have very low expansion or contraction angles. When using a pitot tube test setup, the ductwork upstream of the traverse plane must have a straight run of at least ten duct diameters and a flow straightener that meets specific construction standards. If flow nozzles are used, they must be manufactured to tight dimensional tolerances and in many

cases must have flow settling screens upstream of them. These screens ensure that the flow entering the nozzles is uniform to a high degree.

Field testing instruments are typically not manufactured with the same precision, or as accurate or calibrated with the same frequency as laboratory instruments. So when comparing field test data to the catalog level, it is reasonable to use a testing tolerance greater than that shown in Figure 15.

Troubleshooting Guide — Case Studies

The rest of this newsletter consists of case studies that demonstrate some of the most common field performance problems and the logic that was followed in figuring out what the problem was.

Case Study 1

System Resistance Higher Than Anticipated

This case study demonstrates one of the most common fan performance problems. A 36" tubeaxial fan was selected and installed to deliver 15,000 CFM at a static pressure of 1.70 in. w.g. After the fan was installed, an air performance test indicated a flow rate of 13,600 CFM with a static pressure of 1.68 in. w.g. and 6.8 BHP.

Further investigation revealed that four additional elbows and 10 feet of additional duct length was in order to clear some obstructions, as shown in the figure below. The additional ductwork increases the resistance to flow resulting in a new system line as shown on the curve. We would expect the fan to operate where the new system curve intersects the catalog curve, at 14,080 CFM and 1.80 in. w.g. The difference between the measured performance and the expected performance is due to a combination of test error and system effect due to the elbow located upstream of the fan.

To get the design flow rate, we can use the fan laws to determine the increase in fan speed required:

$$RPM_{new} = 1196 \times \left(\frac{15000}{13600} \right) = 1319$$

$$HP_{new} = 6.8 \times \left(\frac{1319}{1196} \right)^3 = 9.12$$

$$SP_{new} = 1.68 \times \left(\frac{1319}{1196} \right)^2 = 2.04$$

Figure 16a. System as Designed

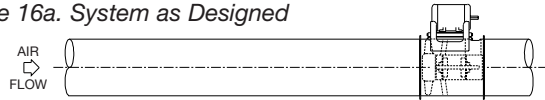

Figure 16b. System as Installed

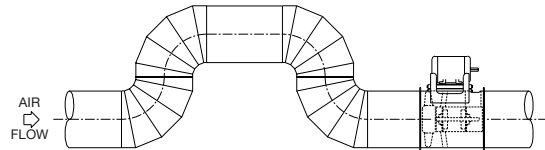
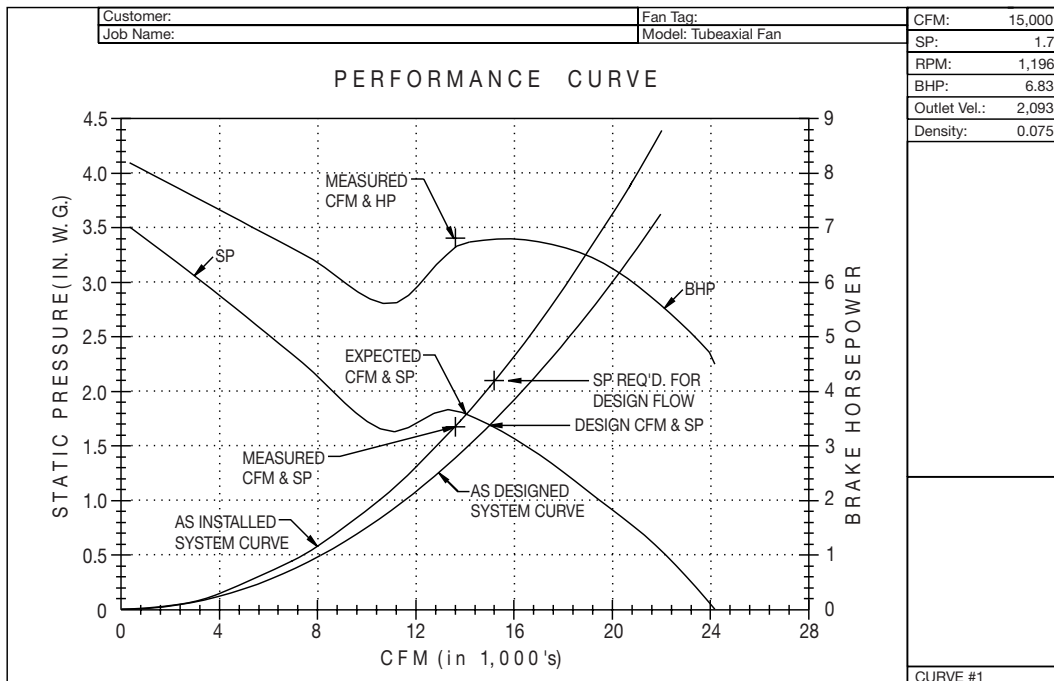

Figure 17. Measured and Expected Performance Curves



Case Study 2

System Effects Due to Spinning Air and an Obstructed Inlet

Two plenum fans were selected to operate in parallel to deliver 80,000 CFM (40,000 CFM each) at a static pressure of 1 in. w.g. The system installation is at 5,200 feet above sea level and handles room temperature air. Figure 18 is a sketch of the duct system and Figure 19 shows the performance curve. Air balance test reports indicated that the airflow was approximately 31,000 CFM through each fan, with a static pressure of 1 in. w.g. Because of the high elevation, air density corrections were made to all static pressure and velocity pressure readings. Notice that the density shown in Figure 19 is at the high elevation.

An investigation of the duct system revealed two problems. One was that the duct geometry caused the air in the vertical duct section below the fan inlets to spin in the direction of wheel rotation. The streamlines sketched in Figure 18a show the general pattern of the airflow.

The other problem was airflow monitoring probes mounted in the throats of the fan inlets. The throat of a fan inlet is one of the most performance-sensitive parts of a centrifugal fan. The velocity in the throat can be 10,000 fpm or higher, so obstructions can result in significant pressure losses. In addition, subtle changes in the velocity profile at the throat can have significant effects on fan performance.

To correct the problem with the spin, flow straighteners were added at the lower portion of the vertical duct sections. These straighteners eliminated most of the spin and as a result the airflow increased to 34,000 CFM.

The next step was to remove the probes from the inlets. When this was done, the performance increased to 41,000 CFM with a static pressure of 1 in. w.g. Removing the probes increased the flow rate by 25%!

Another thing to be careful with when measuring the performance of plenum fans is the location of the static pressure tap in the fan outlet plenum. The high velocity exiting the fan impeller swirls around in the plenum. To get an accu-

rate static pressure reading, you need to find a “dead spot” which is not affected by the swirling, turbulent air. Typically, calm areas are found in the corners, but it may take some searching to find a good spot. In this case, the static pressure in the plenum varied by 20% depending on location.

Notice that the last test point is above the catalog performance. This could be due to test error, but it also could be real. The performance for this fan is based on tests done on a size 365. Typically, larger fans perform better than smaller fans.

Figure 18. Duct System

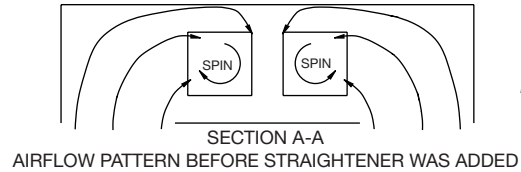

Figure 18a.

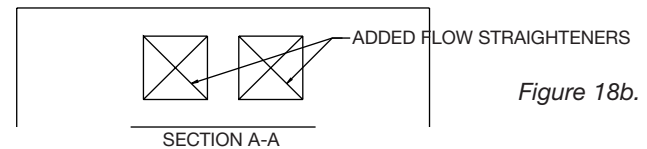

Figure 18b.

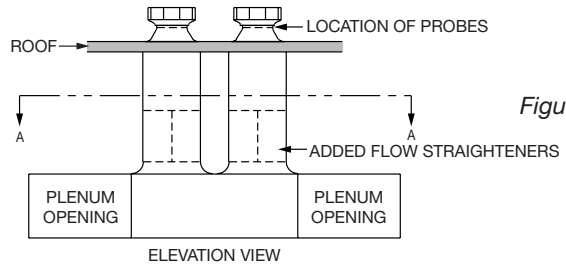
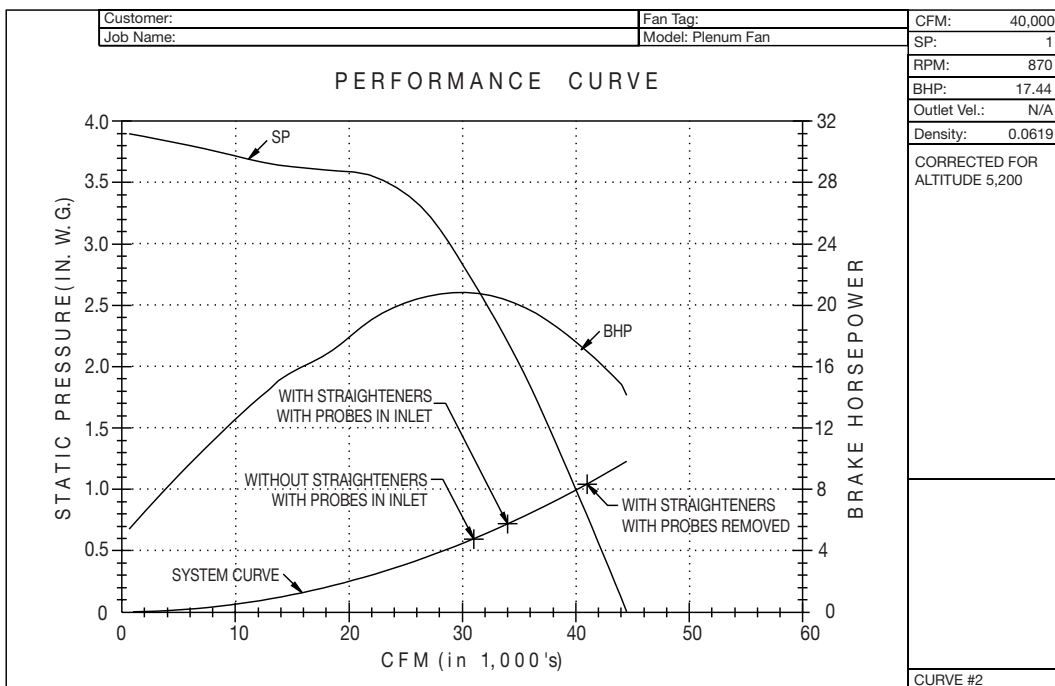

Figure 18c.

Figure 19. Performance Curves With and Without Straighteners



Case Study 3

Air Handling Unit Factory Test Low on Air

An air handling unit manufacturer performed a factory air performance test on one of their units utilizing a DWDI fan. A short length of duct, as shown in the figure, was added to the outlet of the unit to determine the flow rate using a pitot tube traverse. The dimensions of the air handling unit outlet and the duct section match the dimensions of the fan outlet.

The fan was selected to deliver 20,000 CFM at 4 in. w.g. static pressure. Restriction was added to the outlet of the duct by closing a control damper until the pressure rise across the fan was 4 in. w.g. and a pitot tube traverse was performed.

The results of the pitot tube traverse indicated that the flow rate was 16,070 CFM. The air handling unit manufacturer called the fan manufacturer, upset that the fan was 20% low on flow rate.

Key to solving this problem is to remember that fans and duct systems interact along system lines and there are tolerances associated with field tests and catalog performance.

The curve shows the catalog performance and the measured test point. Also shown are system lines drawn through the design point and the measured point.

The difference between the measured performance and the point where the "as tested" system line intersects the catalog curve is 3%. This falls within AMCA's certified ratings program check test tolerance which takes into account manufacturing variations and laboratory test accuracy. A portion of the difference could be due to inaccuracies associated with the test setup. The AMCA laboratory test code requires 10 equivalent duct diameters and a flow straightener between the fan outlet and the pitot tube traverse plane. Since this test setup does not have this there may be more inaccuracies in the test data.

In either case, the first fan law tells us that by increasing the fan speed by 3% the measured test point will move to the catalog curve. After the increase in fan speed, the duct restriction was readjusted to maintain the 4 in. w.g. across the fan. The flow rate was rechecked and found to be very close to 20,000 CFM. A 3% increase in fan speed along with an adjustment in system resistance resulted in an increase in flow rate of 20%. This case study demonstrates that comparing tested performance with cataloged performance along a constant pressure line can make fan performance appear to be a lot worse than it really is.

Figure 20. Air Handling Unit With Added Duct

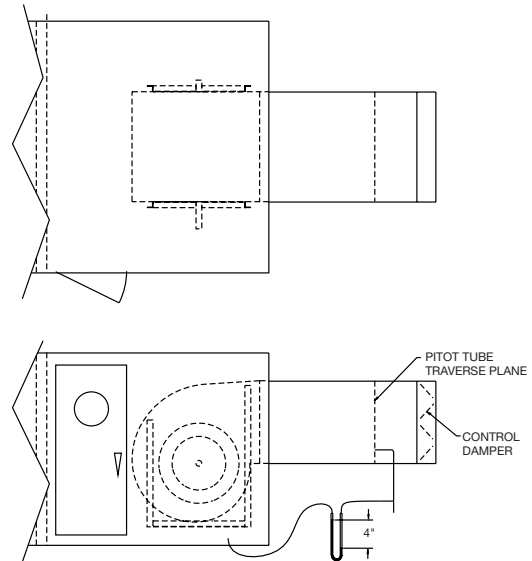
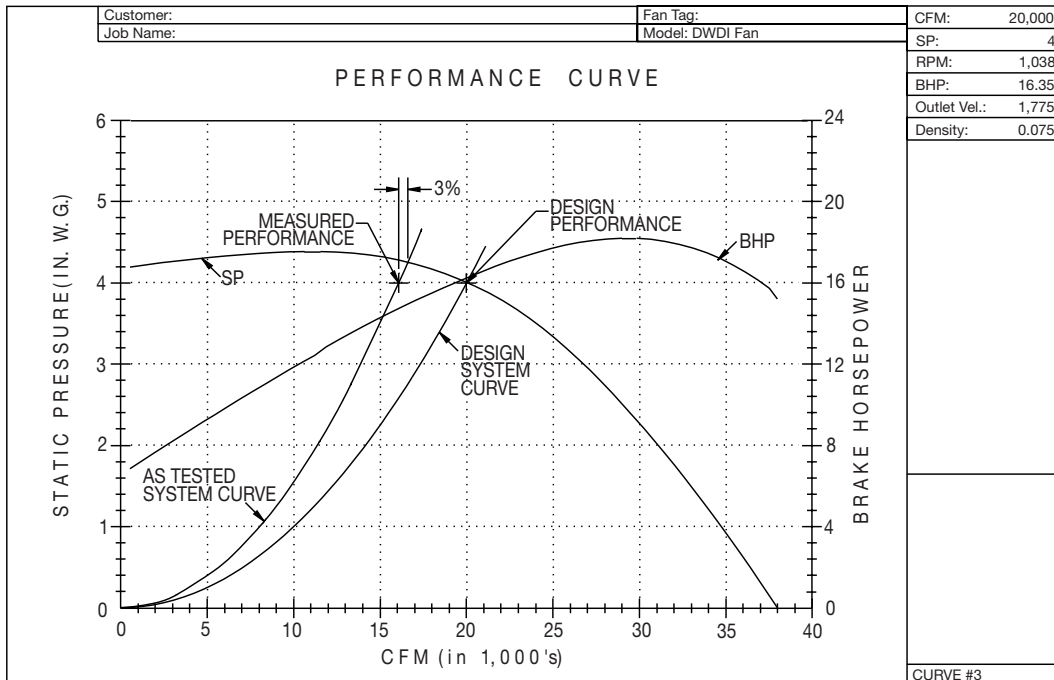

Figure 21. Air Handling Unit Measured and Expected Performance Curves



Case Study 4

System Effect Due to Fan Mounted at the Discharge of a Cyclone Dust Collector

A backward curved industrial fan was selected to deliver 15,000 CFM at a static pressure of 18 in. w.g. on a dust collection system that used a cyclone as an air cleaner. A field performance test indicated that the actual performance was 12,800 CFM, 13.1 in. w.g., and 39.4 BHP.

Cyclones clean by spinning the air and using the centrifugal force acting on the dust particles to separate them from the air. The air usually enters tangentially at the top of the cyclone, spins in one direction down along the outside, and then returns up and out the top of the cyclone, spinning in the opposite direction. The dust is flung to the outside of the cyclone walls, and slides down to where it is collected at the bottom of the cyclone.

The spinning air exiting the cyclone affects the fan performance. In this case, the spin was in the direction of wheel

rotation, lowering the static pressure, flow rate, and horsepower. If the spin were opposite wheel rotation, static pressure and flow rate would increase with a dramatic increase in horsepower and reduction of fan efficiency.

To correct the problem, straighteners were added to the inner cylinder at the top of the cyclone. They prevented the spinning air from entering the fan and allowed it to operate closer to its cataloged performance level.

After installation of the straighteners, the performance was measured again and found to be 14,500 CFM, 17.7 in. w.g. and 53 BHP. Notice that the measured flow rate and static pressure are above the system line defined by the original test point. This is due to the added resistance of the straightener. This point is also slightly below the cataloged performance curve, but certainly within an acceptable tolerance for a field test. The horsepower point is above the cataloged curve. This is likely due to belt drive losses and inaccuracies in determining horsepower from amp and voltage data.

Figure 22. Cyclone Flow Patterns

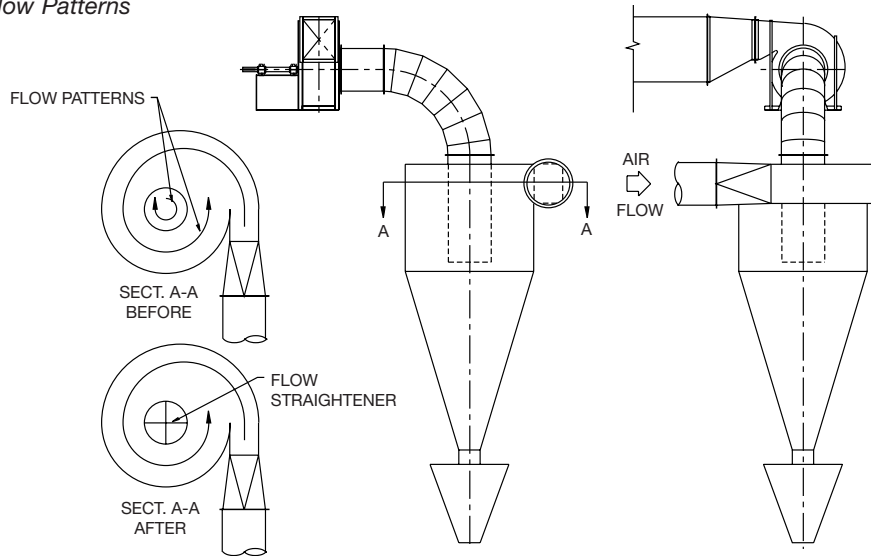
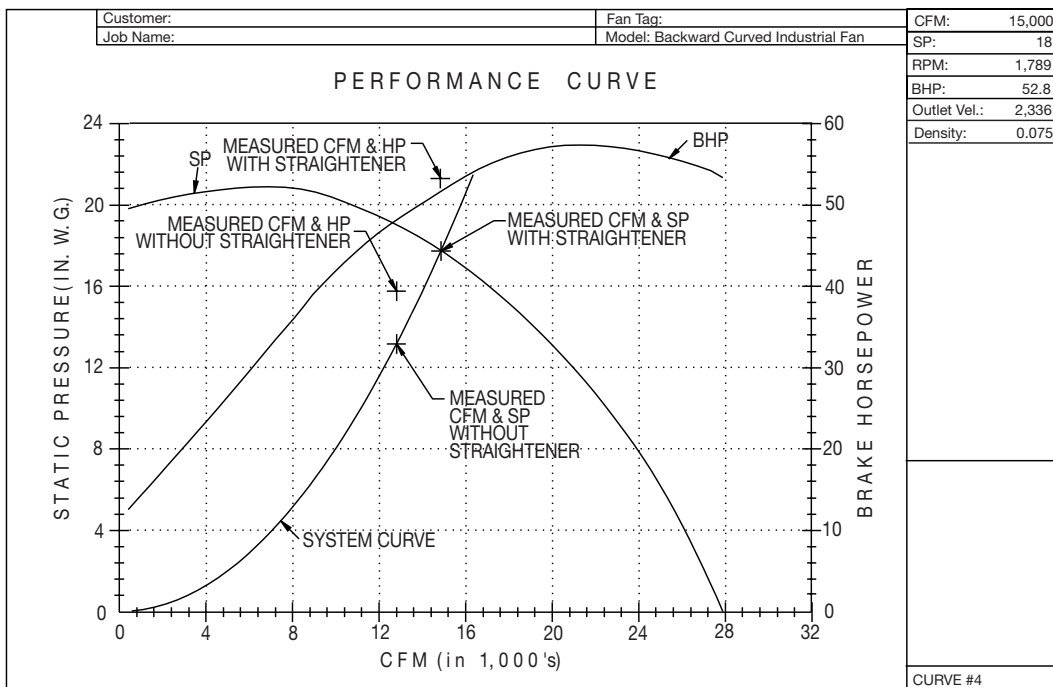

Figure 23. Cyclone Performance Curve With and Without Straightener



Case Study 5 Industrial Fan Without an Inlet Bell

An industrial fan was selected to deliver 4,600 CFM at a static pressure of 18.8 in. w.g. and ordered with a plain inlet and an inlet screen. The fan was installed on a system with an open inlet and ductwork connected on the outlet. A performance test indicated that the actual performance was 3,988 CFM at 14.8 in. w.g. static pressure.

The key to solving this problem is to see how the fan was tested for its catalog ratings. Industrial fans are frequently used in material or dust conveying systems and are designed with relatively small inlets so that conveying velocities are maintained. This reduces the effective open inlet and fan performance drops. When an inlet bell was added to the fan and the screen was left in place, the performance increased to 4,329 CFM at 16.7 in. w.g. With a ducted inlet or with a bell mouth, the velocity profile at the fan inlet is uniform, as shown in the figure below.

This is still below the expected performance level and is due to the screen located at the fan inlet. The screen reduces performance similar to the probes described in Case Study 2. When the screen was removed the performance increased to 4,503 CFM and 18.1 in. w.g. Figure 25 shows the measured performance points, the catalog performance curve, and a dashed line that shows the AMCA check test tolerance. Performance points that lie above the tolerance curve meet AMCA's check test tolerance. As you can see, the last point is within AMCA's tolerance on the catalog curve. Notice that all of the points fall on one system

resistance line since the duct system remained constant and we were only modifying the fan.

As a final test, a new screen was made and mounted closer to the inlet of the bell mouth where the air velocity is much lower. This screen had an immeasurable effect on fan performance.

Figure 24a. With Open Inlet

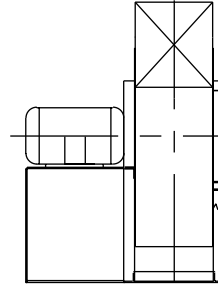

Figure 24b. With Inlet Bell

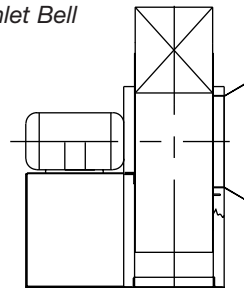
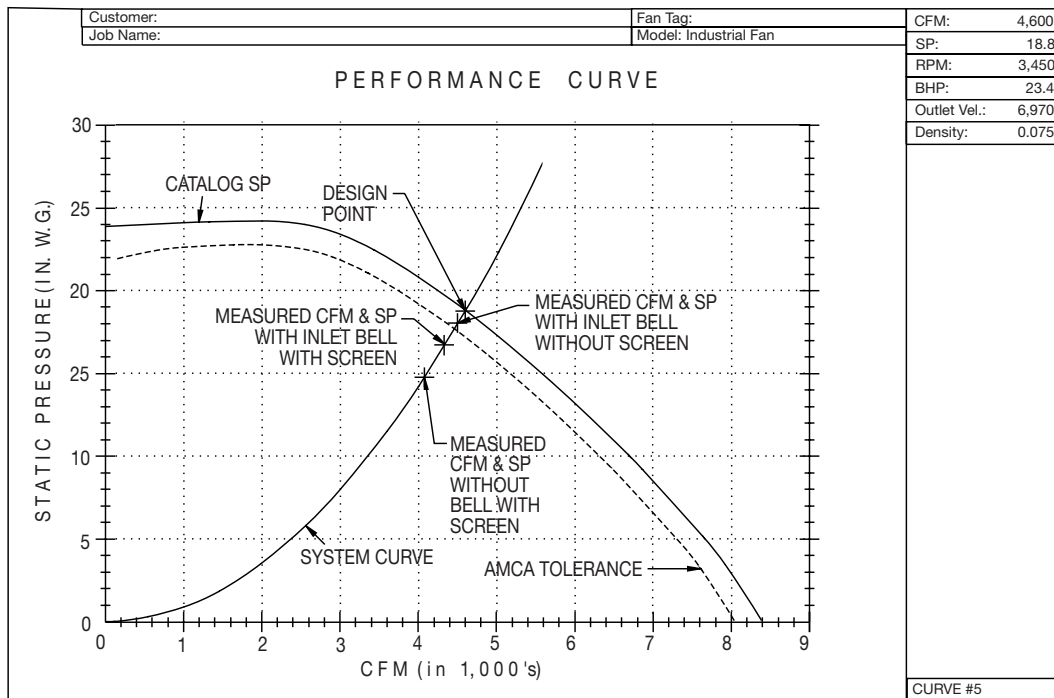

Figure 25. Performance Curves With and Without Inlet Bell





Twin City Fan Companies, Ltd.

Designers & Manufacturers of Air Moving Equipment



July 2000

6969 Timber Lane • Minneapolis, MN 55422-3237
Phone (763) 551-7600 • Fax (763) 551-7603 • www.twincityfan.com